

Varispeed-606PB3

PLASTIC-COVERED BOOK-SIZE ALL-DIGITAL
LOW-NOISE INVERTER

MODEL : CIMR-PBA2, -PBE2 (3-PHASE SERIES)
CIMR-PBAB, -PBEB (SINGLE-PHASE SERIES)

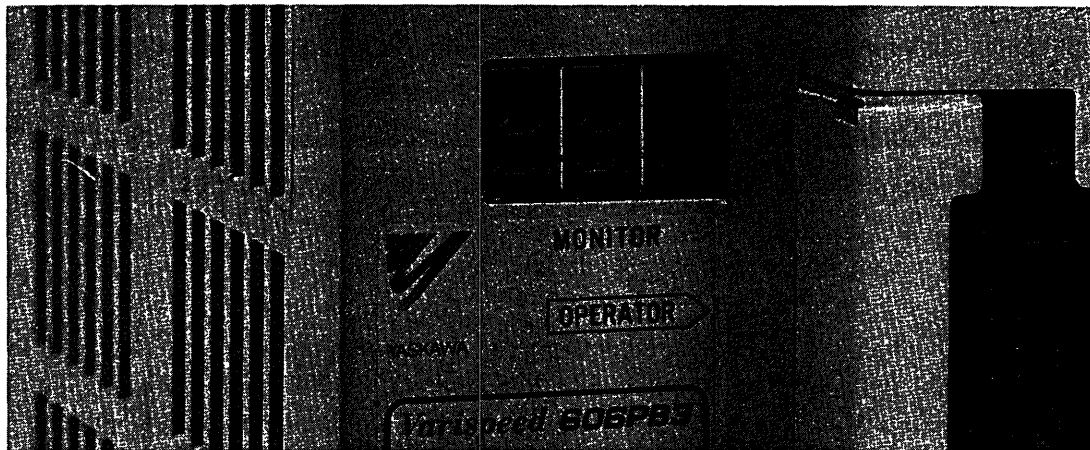

Before initial operation read these instructions thoroughly, and retain for future reference



This instruction manual is composed of 2 sections: The first section describes handling, wiring, operation, maintenance/inspections, troubleshooting and specifications of the Varispeed-606PB3 series (hereafter called VS-606PB3). The second section outlines the digital operator (option) performance, constants, operation, etc.

Before using the VS-606PB3, a thorough understanding of this manual is recommended.

This manual will be of great help for daily maintenance, inspection and troubleshooting.

In this manual, “constant (No.□□)” indicates the constant number related to the contents described in Par. 2.9 “DESCRIPTION OF FUNCTIONS AND CONSTANTS”.

CONTENTS

1 INVERTER VS-606PB3 MAIN UNIT

1.1 PARTS NAMES OF VS-606PB3···2	1.6 MAINTENANCE·····15
1.2 RECEIVING ······3	1.7 FAULT DISPLAY AND TROUBLESHOOTING·····16
1.3 INSTALLATION ······4	1.8 SPECIFICATIONS ······20
1.4 WIRING ······5	
1.5 OPERATION ······11	

2 DIGITAL OPERATOR

2.1 INSTALLATION ······28	2.6 CORRECTIVE FUNCTION ····35
2.2 DESCRIPTION OF DIGITAL OPERATOR DISPLAY AND OPERATING SECTIONS ·····29	2.7 MONITOR·····37
2.3 FUNCTION/CONSTANT SETTING ······30	2.8 FUNCTION/CONSTANT LIST·38
2.4 DIGITAL OPERATOR OPERATION EXAMPLE ·····33	2.9 DESCRIPTION OF FUNCTIONS AND CONSTANTS ······43
2.5 CONSTANT INITIALIZATION AND WRITE-IN PROHIBITION ·34	2.10 PROTECTIVE FUNCTIONS··64
	2.11 PROTECTIVE FUNCTIONS (WARNINGS) ······66

WARNING

- 1) After turning OFF the main circuit power supply, do not touch circuit components until "CHARGE" lamp is extinguished. The capacitors are still charged and can be quite lethal.
- 2) Do not touch the wiring while power is applied to the circuit.
- 3) Do not check signals during operation.
- 4) Be sure to ground VS-606PB3 using the ground terminal (G) (E).
- 5) Never connect main circuit output terminals (T1) (U), (T2) (V), (T3) (W) to AC main circuit power supply.

CAUTION

- 1) All the potentiometers of VS-606PB3 have been adjusted at the factory. Do not change their settings unnecessarily.
- 2) Do not perform any dielectric tests on any part of the VS-606PB3 unit. It is electronic equipment using semi-conductors and vulnerable to high voltage.
- 3) Make sure to tighten screws on the main circuit and control circuit terminals or mount pin connectors of the digital operator without fail.

1 INVERTER VS-606PB3 MAIN UNIT

1.1 PARTS NAMES OF VS-606PB3

The following shows the VS-606PB3 connected with the digital operator (option).

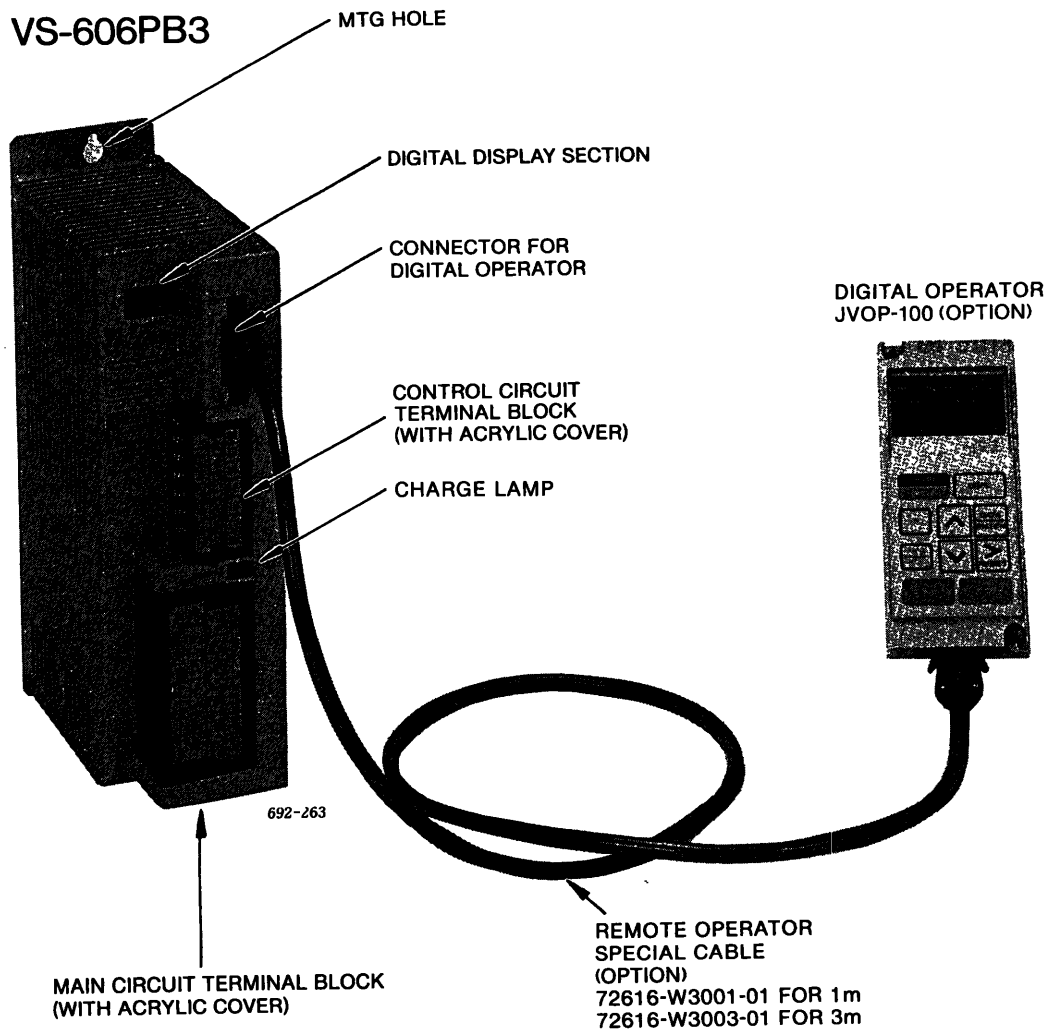

1.2 RECEIVING

This VS-606PB3 has been put through demanding tests at the factory before shipment. After unpacking, check for the following.

- Verify the part numbers with the purchase order sheet and/or packing slip.
- Transit damage.

If any part of VS-606PB3 is damaged or lost, immediately notify the shipper.

NAMEPLATE DATA

UL Certification for Types 3-phase, 200VAC, 0.25HP (0.2kW)

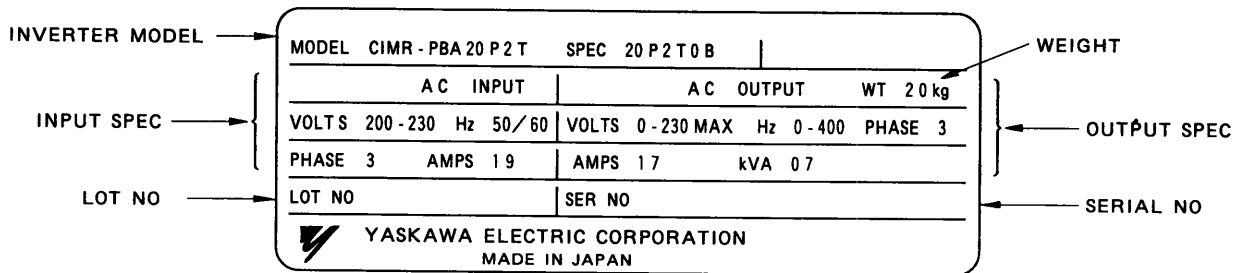

• MODEL DESIGNATION

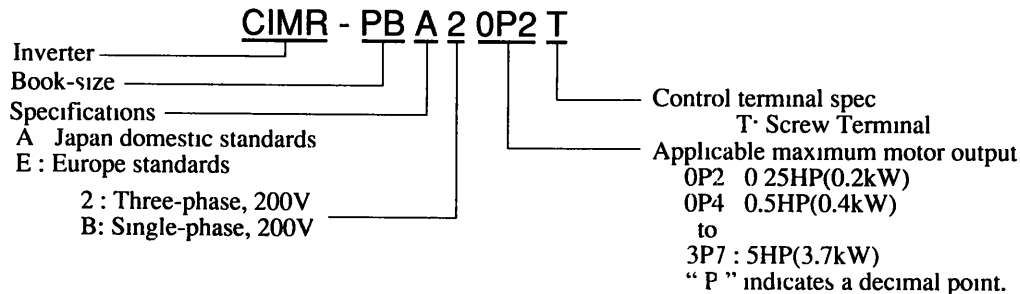

• SPEC DESIGNATION

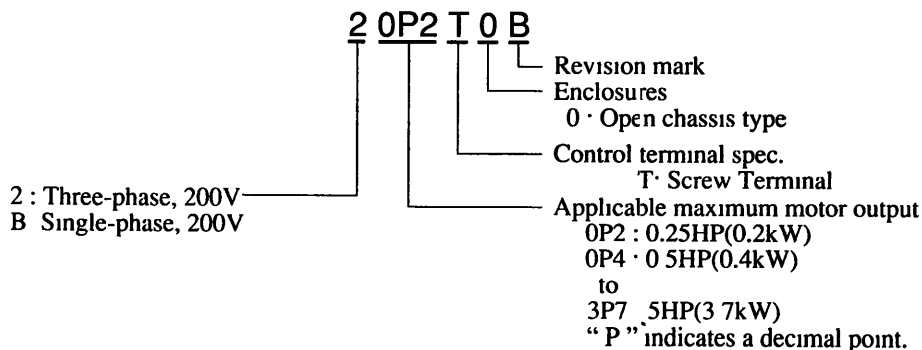

1.3 INSTALLATION

1.3.1 Location

Location of the equipment is important to achieve proper performance and normal operating life. The VS-606PB3 units should be installed in areas where the following conditions exist.

- Ambient temperature : +14 to 122°F, -10 to +50°C.
- Protected from rain, oil mist or moisture.
- Protected from direct sunlight.
- Protected from corrosive gases or liquids.
- Free from airborne dust or metallic particles.
- Free from vibration.
- Free from magnetic noise.
- Protected from high humidity.
- Free from radioactive substances.
- Free from combustibles.

CAUTION

When mounting units in a common enclosure, install a cooling fan or some other means to cool the air entering the inverter below 113°F (45°C).

1.3.2 Mounting Space

Install VS-606PB3 vertically and allow sufficient space for effective cooling as shown in Fig. 1.

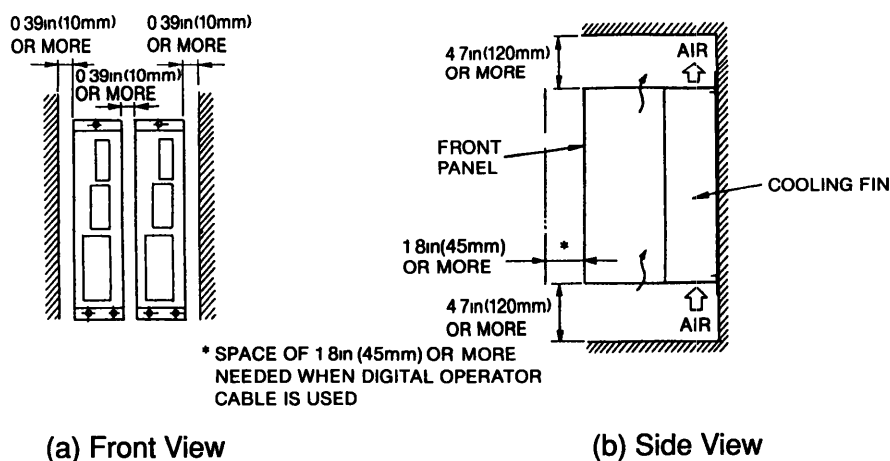

Fig. 1 Mounting Space

Note : For external dimensions and the panel drilling plan, refer to Par. 1.8.4 "Dimensions in inches (mm)" on page 23.

1.4 WIRING

IMPORTANT

Use closed-loop connectors sized for the wire gauge involved.
 Connectors should be installed using the correct crimp tool specified by the connector manufacturer.

Refer to Par. 1.8.3 “Terminals” for details of terminals.

1.4.1 Main Circuit

1.4.1.1 Main circuit wiring

Connect wiring as shown in Fig. 2.

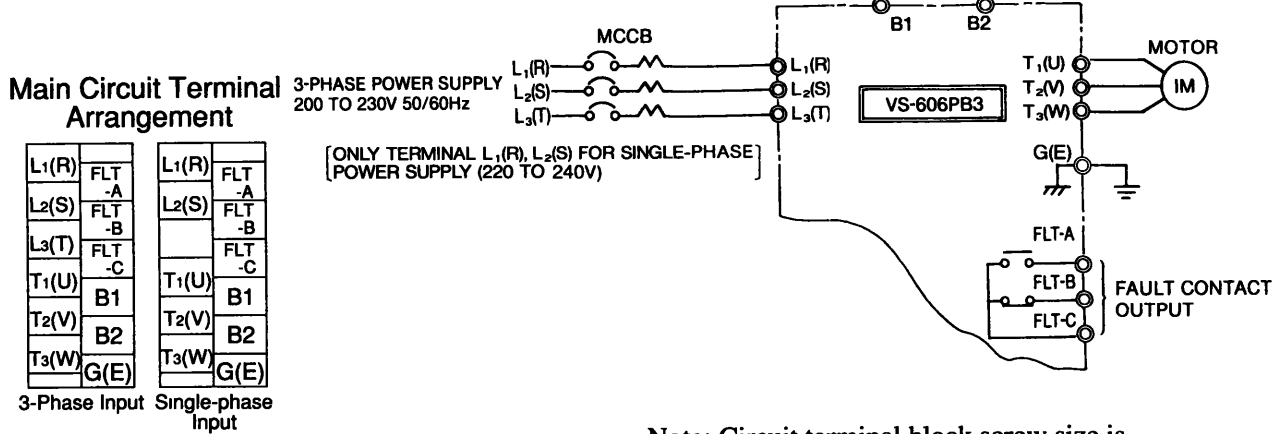

Note: Circuit terminal block screw size is
 M4 for models of 0.25 to 2HP (0.2 to 1.5kW),
 M5 for models of 3 and 5HP (2.2 and 3.7kW).

Fig.2 Main Circuit Wiring

1.4.1.2 Molded-case circuit breaker (MCCB) and power supply magnetic contactor(MC)

Be sure to connect MCCBs between power supply and VS-606PB3 input terminals (L1) (R) (L2) (S), (L3) (T). Recommended MCCBs are listed in Table 1.

When a ground fault interrupter is used, select the one not influenced by high frequency, and setting current should be 200mA or over and operating time, 0.1 sec or over to prevent malfunction.

(Example) NV series by Mitsubishi Electric Co., Ltd. (manufactured in and after 1988),
 EGSG series by Fuji Electric., Co., Ltd. (manufactured in and after 1984)

Table 1 Molded-case Circuit Breakers and Magnetic Contactors

VS-606PB3	Model CIMR-		PBA20P2	PBA20P4	PBA20P7	PBA21P5	PBA22P2	PBA23P7
			PBAB0P2	PBAB0P4	PBAB0P7	PBAB1P5	PBAB2P2	PBAB3P7
	Capacity	kVA	0.7	1.3	2.2	2.8	4.7	7.5
	Rated Output Current	A	1.5	3	5	6.5	11	17.5
Molded-Case Circuit Breakers	Rated Current	3-phase	5A	5A	10A	20A	20A	30A
		Single-phase	5A	10A	20A	20A	40A	50A
Yaskawa Magnetic Contactor Models		3-phase	HI-7E	HI-7E	HI-7E	HI-10-2E	HI-10-2E	HI-20E
		Single-phase	HI-7E	HI-7E	HI-10-2E	HI-15E	HI-20E	HI-30E

1.4.1.3 Surge suppressor

The surge suppressors should be connected to the coils of relays, magnetic contactors, magnetic valves, or magnetic relays. Select type from Table 2.

Table 2 Surge Suppressor

Coils of Magnetic Contactor and Control Relay		Surge Suppressor*		
		Model	Specifications	Code No.
200 V to 230 V	Large-size Magnetic Contactors	DCR2- 50A22E	250 VAC 0.5μF+ 20Ω	C002417
	Control Relay MY-2, -3(OMRON) HH-22, -23(Fuji) MM-2, -4(OMRON)	DCR2- 10A25C	250 VAC 0.1μF+ 100Ω	C002482
400 to 460V Units		DCR2- 50D100B	1000 VDC 0.5μF+ 220Ω	C002630

*Made by MARCON Electronics.

1.4.1.4 Wiring

(A) Main Circuit Input/Output

- (1) Phase rotation of input terminals L1 (R) , L2 (S) , L3 (T) is available in either direction, clockwise or counterclockwise.
- (2) When inverter output terminals T1 (U) , T2 (V) , and T3 (W) are connected to motor terminals T1 (U) , T2 (V) , and T3 (W) , respectively, motor rotates counterclockwise, when viewed from opposite drive end, upon forward run command. To reverse the rotation interchange any two of the motor leads.
- (3) Never connect AC main circuit power supply to output terminals T1 (U) , T2 (V) , or T3 (W) .
- (4) Care should be taken to prevent contact of wiring leads with the VS-606PB3 cabinet, for a short-circuit may result.
- (5) Insert an L noise filter to the VS-606PB3 output, but never connect power factor correction capacitor, LC or RC to VS-606PB3 output.
- (6) Never open or close contactors in the output circuit unless inverter is properly sized.
- (7) Be sure to tighten the main circuit terminal screws.

(B) Wire Size

Table 3 shows wire sizes and types.

Table 3 Wire Sizes

Main Circuit and Fault Contact Circuit

VS-606PB3 Model CIMR-	Inverter Capacity kVA	Terminal Symbol	Terminal Screw	75°C COPPER Wire Size		Wire Type
				(AWG)	(mm ²)	
PBU20P2I PBUB0P2I	0.7	L1(R) L2(S) L3(T) T1(U) T2(V) T3(W) B1 B2	M4	14-10	2.5-5	Power cable 600V vinyl Sheathed lead or equivalent
		G (E)	M4	14-10	2.5-5	
		FLT-A FLT-B FLT-C	M4	16-14	1.25-2	
PBU20P4I PBUB0P4I	1.3	L1(R) L2(S) L3(T) T1(U) T2(V) T3(W) B1 B2	M4	14-10	2.5-5	
		G (E)	M4	14-10	2.5-5	
		FLT-A FLT-B FLT-C	M4	16-14	1.25-2	
PBU20P7T PBUB0P7I	2.2	L1(R) L2(S) L3(T) T1(U) T2(V) T3(W) B1 B2	M4	14-10	2.5-5	
		G (E)	M4	14-10	2.5-5	
		FLT-A FLT-B FLT-C	M4	16-14	1.25-2	
PBU21P5T PBUB1P5T	2.8	L1(R) L2(S) L3(T) T1(U) T2(V) T3(W) B1 B2	M4	14-10	2.5-5	
		G (E)	M4	12-10	3.5-5.5	
		FLT-A FLT-B FLT-C	M4	16-14	1.25-2	
PBU22P2I PBUB2P2I	4.7	L1(R) L2(S) L3(T) T1(U) T2(V) T3(W) B1 B2	M5	12-8	3.5-8	
		G (E)	M5	12-8	3.5-8	
		FLT-A FLT-B FLT-C	M5	16-14	1.25-2	
PBU23P7T PBUB3P7T	7.5	L1(R) L2(S) L3(T) T1(U) T2(V) T3(W) B1 B2	M5	10-8	5.5-8	
		G (E)	M5	10-8	5.5-8	
		FLT-A FLT-B FLT-C	M5	16-14	1.25-2	

* Terminal L3 not provided for single-phase series.

Control Circuit (Common to All Models)

Terminal Symbol	Terminal Screw	75°C Copper Wire Range		Wire Type
		(AWG)	(mm ²)	
1-20	M3	18-14	0.75-2	Twisted shielded lead with class 1 wiring or equivalent

Closed-loop Connectors

Wire Range		Terminal Screw	Closed-Loop Connectors
(AWG)	(mm ²)		
20	0.5	M3	1. 25-3
18	0.75	M3	1. 25-3
16	1.25	M3	1. 25-3
16	1.25	M4	1. 25-4
16	1.25	M5	1. 25-5
14	2	M3	2-3
14	2	M4	2-4
14	2	M5	2-5
12	3.5	M4	5. 5-4
12	3.5	M5	5. 5-5
10	5.5	M4	5. 5-4
10	5.5	M5	5. 5-5
8	8	M5	8-5
6	14	M5	8-14

1. 25-3
 ↳ SCREW SIZE
 ↳ WIRE SIZE

IMPORTANT

- Lead size should be determined considering voltage drop of leads.
 Voltage drop can be obtained by the following equation : select such lead size that voltage drop will be within 2% of normal rated voltage.
 phase-to-phase voltage drop (V) = $\sqrt{3} \times \text{lead resistance } (\Omega/\text{km}) \times \text{wiring distance (m)} \times \text{current (A)} \times 10^{-3}$
- Insertion of power supply coordination AC reactor
 When the power supply capacity exceeds 600 kVA, connect an AC reactor at the inverter input side for power supply coordination. This reactor is also effective for power factor improvement of the power supply.
 Refer to Pars. 1.8.5 and 1.8.6 on pages 25 and 26.
- Wiring distance between inverter and motor
 If total wiring distance between inverter and motor is excessively long and inverter carrier frequency (main transistor switching frequency) is high, harmonic leakage current from the cable will increase to affect the inverter unit or peripheral devices. If the wiring distance between inverter and motor is long, reduce the inverter carrier frequency as shown below. Carrier frequency can be set by constant No. 40. For details, refer to "CARRIER FREQUENCY" on page 55. Carrier frequency is set to 10 kHz at the factory prior to shipping.

Wiring Distance between Inverter and motor	Up to 30m	Up to 50m	Up to 100m	100m or more
Allowable Carrier Frequency (Constant No. 40 set value)	15 kHz or less (6)	10 kHz or less (4)	5 kHz or less (2)	2.5 kHz or less (1)

(C) Grounding

Ground the casing of the VS-606PB3 using ground terminal $\textcircled{\text{G}}$ ($\textcircled{\text{E}}$).

- (1) Ground resistance should be 100Ω or less.
- (2) Never ground VS-606PB3 in common with welding machines, motors, or other large-current electrical equipment, or a ground pole. Run the ground lead in a conduit separate from leads for large-current electrical equipment.
- (3) Use the ground leads which comply with AWG standards and make the length as short as possible.
- (4) Where several VS-606PB3 units are used side by side, all the units should be grounded as shown in (a) or (b) of Fig.3. Do not form a loop with the ground leads.

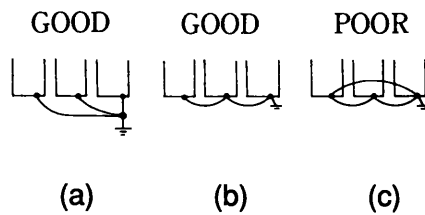

Fig. 3 Grounding of Three VS-606PB3 Units

1.4.2 Control Circuit Wiring

Control signal is connected with screw terminals.

Fig. 4 shows the relationship between I/O signal and screw terminal No.

Control Circuit Terminal Arrangement

1	8	14
2	9	15
3	10	16
4	11	17
5	12	18
6	13	19
7		20

Notes: 1. Separate the control signal wiring from power lines.

2. Use shielded leads or twisted-pair shielded leads for freq. setting signal (analog) and ensure sufficient terminal processing.

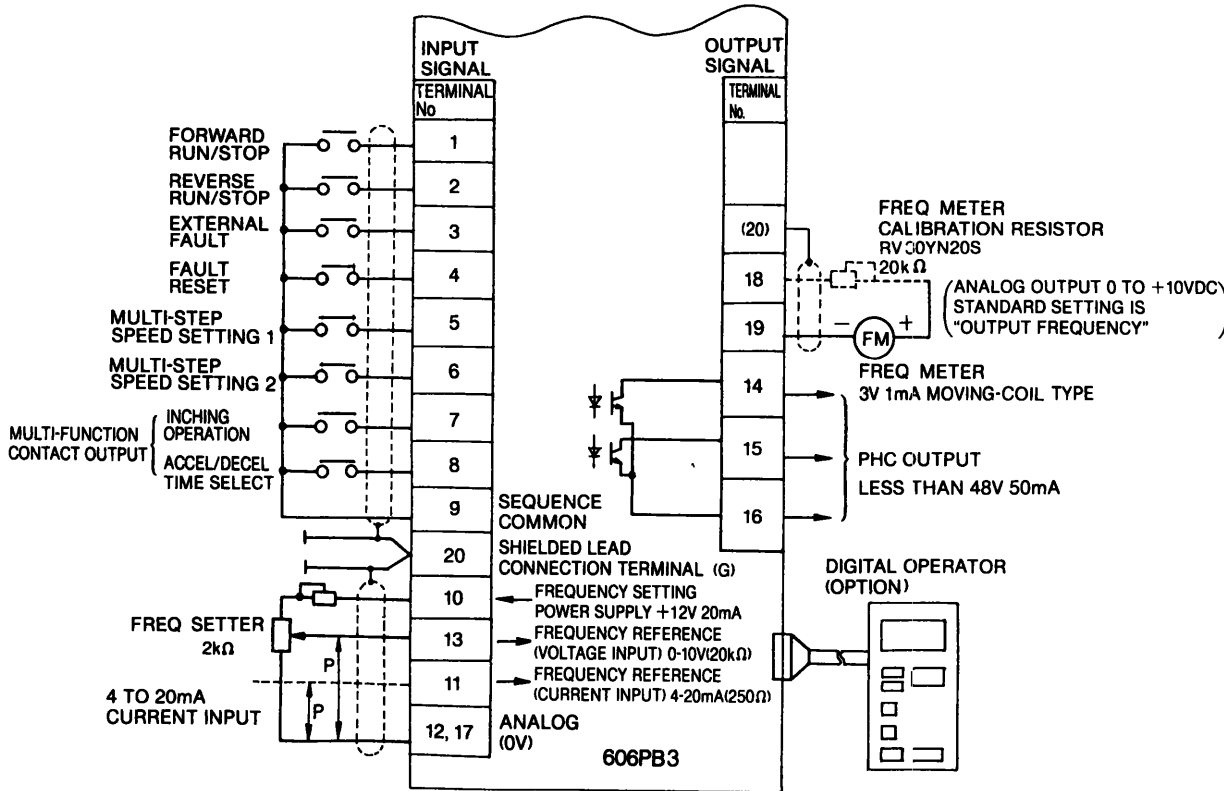
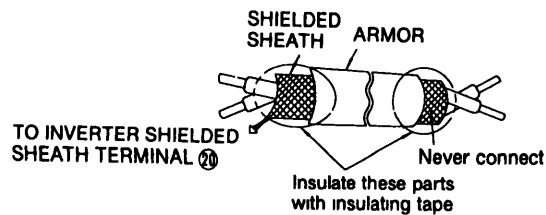

Fig. 4 Control Circuit Terminals

• Shielded Lead Termination



1.5 OPERATION

1.5.1 Checking before Operation

Check the following items after completion of installation and wiring:

- (1) No fault in wiring. Double check that the power supply is not connected to the output terminals (T1) (U), (T2) (V) and (T3) (W).
- (2) No shortcircuit because of wiring contamination (dust, oil, etc.).
- (3) Screws and terminals are tightened. Wiring is provided properly.
- (4) Load status is good.

For safe operation, the motor should be uncoupled from the load.

Pay close attention to output current when the motor is operated with the load coupled.

1.5.2 Operation Method

The inverter can be operated in the following two methods:

Operation by external terminal input

The inverter is operated by frequency setter, operation switches, etc. connected to the external terminals.

It is set to "Operation by control circuit terminal input" at the factory prior to shipping. After completion of control circuit terminal wiring, operation can be started. Therefore, even without the digital operator, operation can be performed.

Each set value such as accel/decel time is preset to a value indicated in and after Par. 2.8 (page 38) at the factory. To change this value, the digital operator must be connected.

The following will be available by connecting the digital operator when the inverter is operated by external terminal:

- Monitoring of output frequency and output current
- Reading and changing of each constant set value
- Checking of the contents at fault occurrence
- Checking of the operation status (FWD/REV run)

Output frequency or output current is displayed in the digital display section.

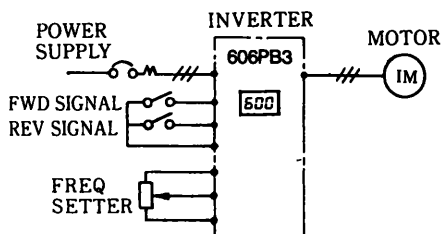

Operation by digital operator

The inverter is operated only by the digital operator, by using the digital operator RUN (run command) key, etc.

Operation is possible by changing the operation mode to "operation by digital operator" mode (No.01=0011). For details, refer to "OPERATION MODE SELECTION", Par. 2.9 (page 43).

Even if the frequency setter or operation switch is not connected, operation can be easily performed.

Refer to Section 2 "DIGITAL OPERATOR (JVOP-100)" (page 27 and beyond) for details of the operation method.

The digital operator is optional and must be ordered separately.

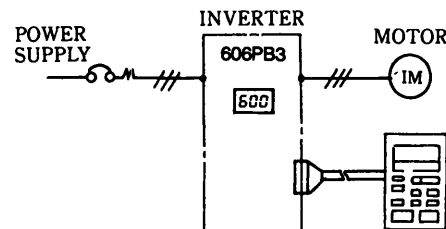

1.5.3 Setting before Operation

Since the standard inverter models are provided with the values indicated in Par. 2.8 (see page 38 and beyond), the digital operator must be used in order to change the constants from the initial values to the values in accordance with the load specifications.

(1) Preset values prior to shipping

The following describes the functions and initial constant set values which are often used for operation.

(a) Output frequency and accel/decel time

For details, refer to the item of “ACCEL/DECEL TIME SETTING” on page 47.

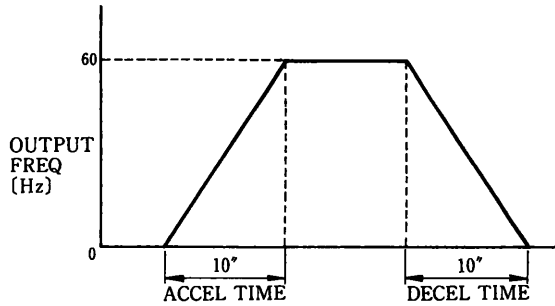

Fig. 5 Output Frequency and Accel/Decel Time

(b) Frequency setting signal and output frequency

For details, refer to Par. 2.6.1 “Adjustment of Frequency Setting Value, Output Frequency Bias (No.23) and Gain (No.22)” on page 35.

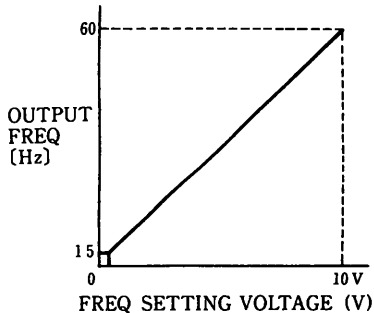

Fig. 6 Frequency Setting Signal and Output Frequency

(c) V/f characteristics

For details, refer to “V/f CHARACTERISTICS SETTING” on page 45.

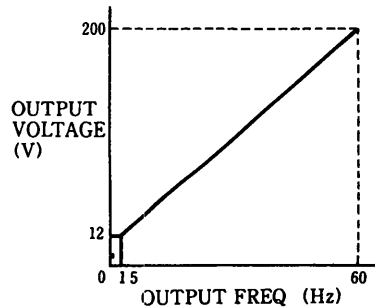

Fig. 7 V/f Characteristics

(2) Motor rated current setting

Since the inverter is provided with an electronic thermal overload to protect the motor from overheating, the motor should be programmed into rated current value described on the motor nameplate to constant (No.19). YASKAWA standard 4-pole motor current value is set as the initial value. For details, refer to “ELECTRONIC THERMAL OVERLOAD FUNCTION” on page 48.

Note : Provide a thermal overload relay or thermal protector when more than one motor is operated simultaneously.

1.5.4 Checking Points at Test Run

Turn ON the power supply after checking that the FWD (or REV) run signal has been turned OFF. Perform test run as described below and check the operation status.

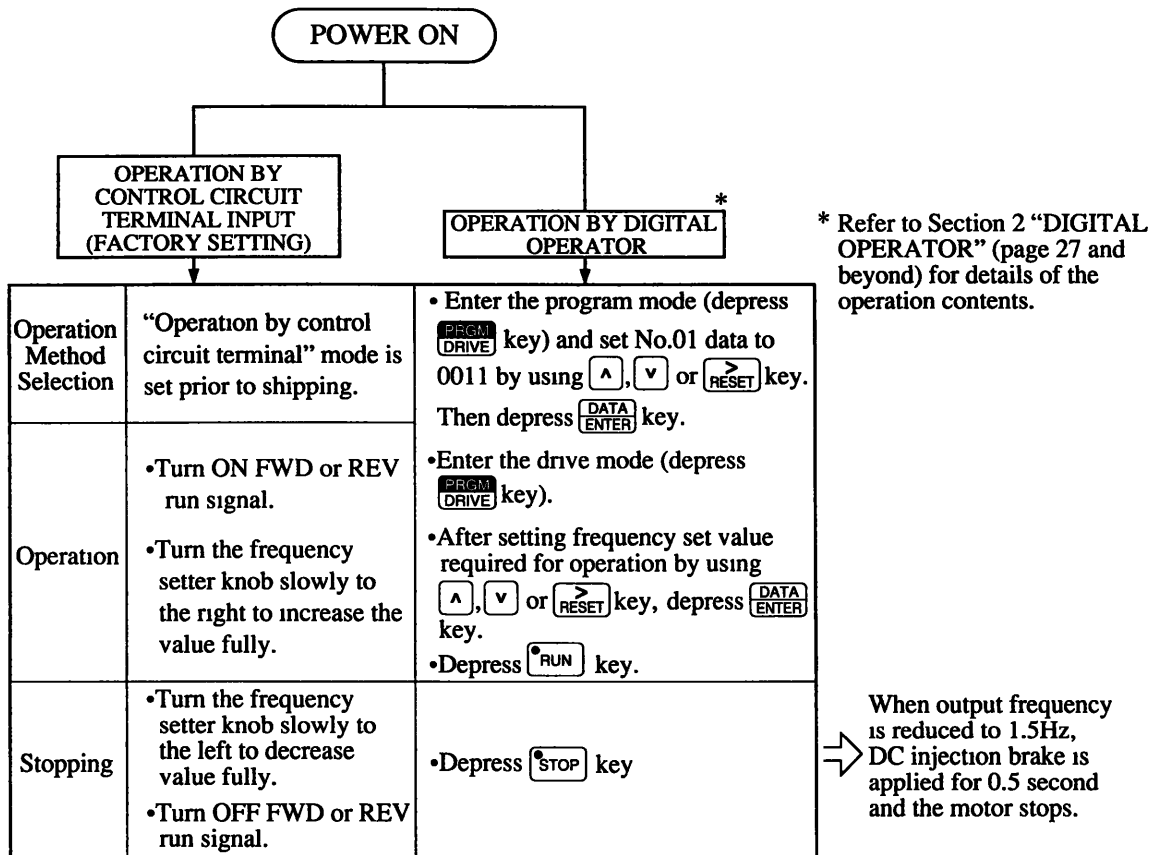

CHECK POINTS

- (1) Motor rotation is smooth.
- (2) Motor rotating direction is proper.
- (3) Motor does not have abnormal vibration or beat.
- (4) Accel/decel is smooth.

1.5.5 Inverter Monitor Display

The inverter display unit (3-digit LED) provided for the standard models has the following display, disregarding the modes (drive mode, program mode).

Display contents can be selected by the 1st digit of constant 21 monitor selection. For details, refer to “DIGITAL DISPLAY UNIT AND MULTIFUNCTION ANALOG OUTPUT MONITOR SETTING” on page 49.

1st digit of constant No.21	{“0”: Output frequency {“1”: Output current	No minus display even in reverse run.
		Less than 100Hz : Displayed in the units of 0.1Hz 100Hz or more : Displayed in the units of 1Hz Less than 10 A : Displayed in the units of 0.1A 10A or more : Displayed in the units of 1A

Output frequency : **50 0**

Output current : **5 0A**

Protection/Alarm Display

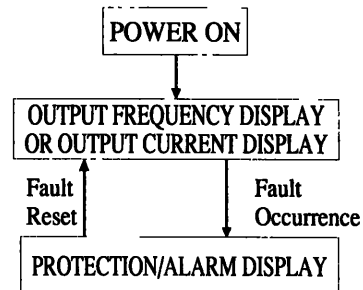

PRECAUTIONS

- (1) The motor does not start up if both FWD and REV run signals are turned ON simultaneously. If they are turned ON simultaneously during run, the motor stops according to the stopping method selection of constant (No.01) 3rd digit. (Deceleration to a stop is selected for factory setting.)
- (2) When output frequency is reduced to 1.5Hz (preset value prior to shipping) at deceleration, the DC injection brake operates for 0.5 second (preset value prior to shipping) and metallic noise is generated by the motor. However, this noise is normal. To eliminate this noise, refer to “DC INJECTION BRAKING” on page 50.
- (3) If a fault occurs during acceleration or deceleration and the motor coasts to a stop, check the motor stopping position and then the following items. For details, refer to Par. 1.7 “FAULT DISPLAY AND TROUBLESHOOTING” on page 16.
 - Load is not excessively large.
 - Accel/decel time is long enough for load.
 Resetting must be performed by fault reset input signal (or  key of the digital operator) or by turning OFF the power supply.

1.6 MAINTENANCE

1.6.1 Periodical Inspection

VS-606PB3 requires very few routine checks. It will function longer if it is kept clean, cool and dry, while observing the precautions listed in “Location”(Par. 1.3.1). Check for tightness of electrical connections, discoloration or other signs of overheating. Use Table 4 as the inspection guide. Before servicing, turn OFF AC main circuit power and be sure that CHARGE lamp is OFF.

Table 4 Periodical Inspection

Component	Check	Corrective Action
External terminals, unit mounting bolts, connectors, etc.	Loosened screws	Tighten
	Loosened connectors	Tighten
Cooling fins	Build-up of dust or dirt	Blow with dry compressed air of 39.2×10^4 to 58.8×10^4 Pa [57 to 85 psi (4 to 6kg·cm ²)] pressure.
Printed circuit board	Accumulation of conductive dust or oil mist.	Clean the board. If dust and oil cannot be removed, replace the inverter unit.
Cooling fan	Abnormal noise or vibration. Whether the cumulative operation time exceeds 20,000 hours or not.	Replace the cooling fan.
Power elements	Accumulation of dust or dirt	Blow with dry compressed air of 39.2×10^4 to 58.8×10^4 Pa [57 to 85 psi (4 to 6kg·cm ²)] pressure.
Smoothing capacitor	Discoloration or odor	Replace the capacitor or inverter unit.

1.6.2 High Voltage Test

Use an insulation resistance tester (500V) to conduct insulation resistance test (high voltage test) on the main control circuit as described below.

- (1) Remove the inverter main circuit and control circuit terminal wiring and execute the test only between the main circuit terminals and ground [ground terminal (G) (E)] as shown in Fig.8.
- (2) The equipment is normal with the insulation resistance tester indicating $1M\Omega$ or more.

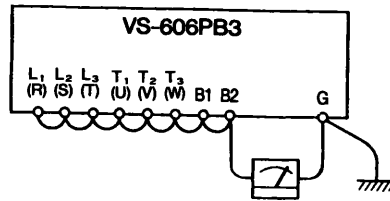

Fig.8 High Voltage Test

Note : Do not conduct high voltage test on the control circuit terminals.

1.7 FAULT DISPLAY AND TROUBLESHOOTING

If a fault occurs and the inverter functions are lost, check for the causes and provide proper corrective actions, referring to the following checking method.

Contact your YASKAWA representative if any fault other than described below occurs, if the inverter itself malfunctions, if any parts are damaged, or if you have any other problems. A list of the YASKAWA representatives is available on the last page.

1.7.1 Checking of Causes

The inverter has protective functions to protect it from faults such as overcurrent or overvoltage. If a fault occurs, the protective functions operate to shut off the inverter output and the motor coasts to a stop. At the same time, the fault contact signal is output.

When the protective functions operate, the digital display unit displays a fault shown in Table 5. Also when the digital operator is used, the same display except for control function faults [indicated in () in Table 5.1] is provided.

Operation can be restarted by turning ON the fault reset input signal (or  key of the digital operator) or turning OFF the power supply once.

Table 5 Fault Display and Contents

Fault Display	Contents	Possible Cause/Corrective Actions
OC (Overcurrent) OC	Inverter output current exceeds 200% of rated current. (Momentary action)	The following causes can be considered: inverter output side short-circuit, excessive load inertia (J), excessively short setting of accel/decel time,[constant (No.09 to 12)] special motor use, motor start during coasting,start of motor with larger capacity than inverter, inverter output side magnetic contactor ON/OFF. Reset after finding the cause.
GF*4 (Ground Fault) GF	Inverter output side is grounded.	Check that the motor or load side wiring is not grounded.
OV (Overvoltage) OV	Main circuit DC voltage exceeds 410V or more because of excessive regenerative energy from motor.	Decel time setting is not sufficient,[constant (No.10, 12)] or minus load (elevators, etc.) is decreasing. Increase decel time or connect a braking resistor (option).
UV (Undervoltage) UV	Undervoltage status is entered. [Main control DC voltage becomes approx. 210V or less (3-phase) or 170V or less (single-phase)].	Input power supply voltage is reduced, phases are opened or momentary power loss occurs, etc. Check the power supply voltage, or check that main circuit power supply wiring is connected properly or terminal screws are tightened well.
OH (Cooling Fin Overheat) OH	Thermistor detects temperature rise caused by inverter overload operation or intake air temperature rise.	Load is too large, V/f characteristics are not proper, setting time is too short or ambient temperature exceeds 113°F (45°K) , etc. Correct load size, V/f set value [constant (No.02 to 08)] or intake air temperature.
(Fuse Blown) (Digital display is extinguished.)	Main circuit fuse is blown.	Replace the inverter
OL1 (Motor Overload) OL1	Motor overload protection operates because of electronic thermal overload.	Correct load size, operation pattern or V/f set value [constant (No.02 to 08)]. Set the rated current value described in the motor nameplate to constant [No. 19].
OL2 (Inverter Overload) OL2	Inverter overload protection operates because of electronic thermal overload.	Correct load size, operation pattern or V/f set value [constant (No.02 to 08)]. Recheck the inverter capacity.
OL3*1 (Overtorque Detection) OL3	Motor current exceeding set value is applied because of machine fault or overload.	Check the machine using status and remove the cause. Or increase the set value up to the machine allowable value [constant (No.38)].
EF3 (External Fault) EF3	Inverter accepts external fault input from external circuit.	Check the external circuitry (sequence).
CPF*3 (Control Function Fault) *2 CPF	Inverter control functions are broken down.	Turn OFF the power supply once and then turn it ON again. If the fault still exists, replace the inverter.

*1 : For OL3 (overtorque detection), fault display or alarm display can be selected according to the constant (No.37) setting. For details, refer to "OVERTORQUE DETECTION FUNCTION" on page 54.

*2 : **CPF** digital operator display contents

*3 : For details of CPF (control function faults), refer to Table 5.1.

*4 : Ground fault display is provided only with model CIMR-PBE.

Table 5.1 Details of CPF Display

Fault Display	Contents	Possible Cause/Corrective Actions
CPF-00	Initial memory fault is detected.	Turn OFF the power supply once and turn it ON again. If the fault still exists, replace the inverter
Display is off. (CPF00) Fault is not displayed. (CPF00)	Transmission error is detected.	
CPF-01	ROM fault is detected	Turn OFF the power supply once and turn it ON again. If the fault still exists, replace the inverter
Display is off. (CPF01) Fault is not displayed. (CPF01)	Transmission error is detected.	
CPF-04 F04 (CPF04)	Constant fault is detected.	Record all data, and then make initialization. Turn OFF the power supply once and turn it ON again. If the fault still exists, replace the inverter. For initialization of constants, refer to Par. 2.5.1 "Constant Initialization" on page 34.
CPF-05 F05 (CPF05)	AD converter fault is detected.	Turn OFF the power supply once and turn it ON again. If the fault still exists, replace the inverter.
CPF-07 F07 (CPF07)	Thermistor fault is detected.	Turn OFF the power supply once and turn it ON again. If the fault still exists, replace the inverter.

Note : Display in () belongs to the digital display section.

1.7.2 Alarm Display and Self-diagnosis

Fault Display	Contents	Possible Cause/Corrective Actions
EF (Simultaneous Input of FWD and REV commands) EF blinks.	Both FWD and REV commands are "closed" for 500ms or more.	Check the sequence circuit
BB (External Baseblock) bb blinks.	External baseblock signal is accepted. (Pay attention since operation restarts by releasing the external baseblock signal.) For the external baseblock signal, refer to "MLTIFUNCTION CONTACT INPUT FUNCTION SELECTION" on page 52.	Check the sequence circuit
UV (Main Circuit Undervoltage) uv blinks.	Main circuit DC voltage is reduced less than detection level when inverter is not outputting.	Check the power supply voltage, main circuit power supply wiring connection or terminal screw tightening.
OL3 (Overtorque Detection) ol 3 blinks.	Motor current exceeding the set value flows due to machine fault or overload.	Check the machine using status and remove the cause. Or increase the set value [constant(No.38)] up to the machine allowable value.

Note : For OL3 (overtorque detection), fault display or alarm display can be selected according to the constant (No.37) setting. For details, refer to "OVERTORQUE DETECTION FUNCTION" on page 54.

1.7.3 Corrective Action for Motor Faults

Table 6 shows the check points and corrective actions of motor faults.

Table 6 Motor Faults and Corrective Actions

Fault	Check Point	Corrective Action
Motor does not rotate.	Power supply voltage is applied to power supply terminals (L1 (R) , L2 (S) , L3 (T)). (Check that charge lamp is on.)	<ul style="list-style-type: none"> •Turn ON the power supply. •Turn OFF the power supply and then ON again. •Check power supply voltage. •Check that terminal screws are tight.
	Voltage is output to output terminals (T1 (U) , T2 (V) , T3 (W)). (Use rectifier type voltmeter.)	•Turn OFF the power supply and then ON again.
	Load is excessively large. (Motor is locked.)	Reduce the load. (Release the lock.)
	Fault is displayed.	Check according to Par. 1.7.1
	FWD or REV run command is entered.	Correct the wiring.
	Frequency setting signal is entered.	<ul style="list-style-type: none"> •Correct the wiring. •Check frequency setting voltage.
	Operation (method selection) mode setting is proper.	Check the operation method selection mode [constant(No.01)] by using the digital operator.
Motor rotating direction is reversed.	Wiring of output terminals (T1 (U) , T2 (V) and T3 (W)) is correct.	Match them to the phase order of motor (T1 (U) , T2 (V) and T3 (W)) .
	Wiring of FWD and REV run signals is correct.	Correct the wiring
Motor rotates but variable speed is not available.	Wiring of frequency setting circuit is correct.	Correct the wiring.
	Operation (method selection) mode setting is correct.	Check operation method selection mode [constant (No.01)] by digital operator.
	Load is not excessively large.	Reduce the load.
Motor r/min is too high (low).	Motor ratings (number of poles, voltage) are proper.	Check the specifications and nameplate.
	Accel/decel ratio by speed changer (gears, etc.) is correct.	Check speed changer (gears, etc.).
	Maximum frequency set value is correct.	Check the maximum frequency set value [constant (No 02)]
	Voltage between motor terminals is not excessively reduced. (Use rectifier type voltmeter.)	Check V/f characteristic set value [constant (No. 02 to 08)].
Motor r/min is not stable during operation.	Load is not excessively large.	Reduce the load.
	Load variation is not excessively large.	<ul style="list-style-type: none"> •Reduce the load variation. •Increase the inverter or motor capacity.
	3-phase power supply is used	Connect an AC reactor to the power supply if single-phase power supply is used.

1.8 SPECIFICATIONS

1.8.1 Specifications

Inverter Model CIMR-PB ₁	3-Phase	20P2T	20P4T	20P7T	21P5T	22P2T	23P7T
	Single-Phase	B0P2T	B0P4T	B0P7T	B1P5T	B2P2T	B3P7T
Max Applicable Motor Output Hp(kW)*1		0.25 (0.2)	0.5 (0.4)	1 (0.75)	2 (1.5)	3 (2.2)	5 (3.7)
Inverter Capacity kVA		0.7	1.3	2.2	2.8	4.7	7.5
Rated Output Current A		1.5	3	5	6.5	11	17.5
Max Continuous Output Current*2 A		1.7	3.4	5.6	7.3	12.4	19.6
Max Output Voltage	3-Phase, 200 to 240V (Proportional to input voltage)						
Max Output Frequency	400Hz (available with constant setting)						
Rated Input Voltage and Frequency	3-Phase 200 to 230V, 50Hz/60Hz			Single-Phase 220 to 240V, 50Hz/60Hz			
Allowable Voltage Fluctuation	±10%						
Allowable Frequency Fluctuation	±5%						
Control Method	Sine wave PWM						
Frequency Control Range	0.1 to 400Hz						
Frequency Accuracy (Temperature Change)	Digital command 0.01% (+14 to 104°F, -10 to 40°C)			Analog command 0.1% (77 ±18°F, 25 ±10°C)			
Frequency Setting Resolution	Digital operator reference 0.1Hz			Analog reference 0.06 Hz/60 Hz			
Output Frequency Resolution	0.1 Hz						
Overload Capacity	150% rated output current for one minute						
Frequency Setting Signal	0 to 10 VDC (20 kΩ), 4 to 20 mA (250Ω)						
Accel/Decel Time	0.1 to 600 sec (Accel/Decel time setting independently)						
Braking Torque	Approx. 20% (Up to 150% possible with optional braking resistor externally mounted) Braking transistor built-in						
V/f Characteristic	Possible to set any of V/f pattern						
Stall Prevention Level	Possible to set operating current						
Instantaneous Overcurrent	Motor coasts to a stop at approx. 200% of inverter rated current						
Ground Fault*5	Protected by electronic circuit						
Overload	Motor coasts to a stop for 1 minute at 150% of inverter rated output current						
Motor Overload Protection	Electronic thermal overload relay						
Overvoltage	Motor coasts to a stop if converter output voltage exceeds 410V						
Undervoltage	3-phase Stops when main circuit DC voltage is approx. 210V or less Single-phase Stops when main circuit DC voltage is approx. 170V or less						
Momentary Power Loss	Stops if power loss is 15ms or longer (setting prior to shipping) (operation continues after recovery from momentary power loss up to approx. 2 seconds by selection of operation mode)*3						
Cooling Fin Overheat	Protected by thermistor						
Power Charge Indication	Charge lamp stays ON until bus voltage drops below 50V						
Input Signals	Operation Signal	Forward operation/Reverse operation by separate commands					
	External Fault	Output stops by external fault input					
	Fault Reset	Releases protection while the function is operating					
	Multifunction Setting	Possible to set max. 9 speed					
	Multifunction Input Selection	Multifunction contact input two of the following signals available to select Multispeed command 3, jog operation, accel/decel time select, 3-wire sequence, external coasting stop					
	Operation State (Photo-coupler output)	Multifunction contact output two of the following signals available to select During running output, zero speed, agreed frequency, output frequency ≥ setting value, during overtorque detection					
Output Signals	Fault Contact	1 NO/NC contact output					
	Built-in Function	The following setting-up is available: frequency reference bias/gain, upper/lower frequency limit, DC injection braking current/time at starting/stopping, full-automatic torque boost, frequency meter calibrating gain, auto restart attempt, prohibited frequency, S-curve accel/decel					
	Monitor Display Function	7 Segments 1 Digit's Display Section Displays output frequency or output current and contents at protective function operation Digital Operator (Option) Displays set frequency, output frequency, output current, direction of rotation, and the fault status Analog Output Monitor Analog output (0 to 10VDC) Possible to select output frequency or output current					
Protective Configuration	Open chassis						
Cooling Method	Self-cooling			Forced cooling			
Mass lb(kg)	4.4(2)	4.4(2)	6.6(3)	6.6(3)	13(6)	13(6)	
Environmental Conditions	Location	Indoor (protected from corrosive gases and dust)					
	Ambient Temperature	+14 to 122°F (-10 to +50°C) (not frozen)					
	Storage Temperature*4	-4 to 140°F (-20 to +60°C)					
	Humidity	90% RH (non-condensing)					
Vibration	Up to 9.81m/s ² (1G) at less than 20Hz, Up to 1.96m/s ² (0.2G) at 20 to 50 Hz						

*1. Our standard 4-pole motor is used to determine applicable motor output.

*2. Allowable values for the applications not requiring overload.

*3: To select "continuous operation after momentary power loss", set constant (No.46) 1st digit to "1".

Continuous operation is available for up to 1 second for models of 1HP (0.75kW) or less or up to 2 seconds for models of 2HP (1.5kW) or greater.



*4. Temperature during shipping (for short period)

*5. Ground fault protection is provided only with model CIMR-PBE

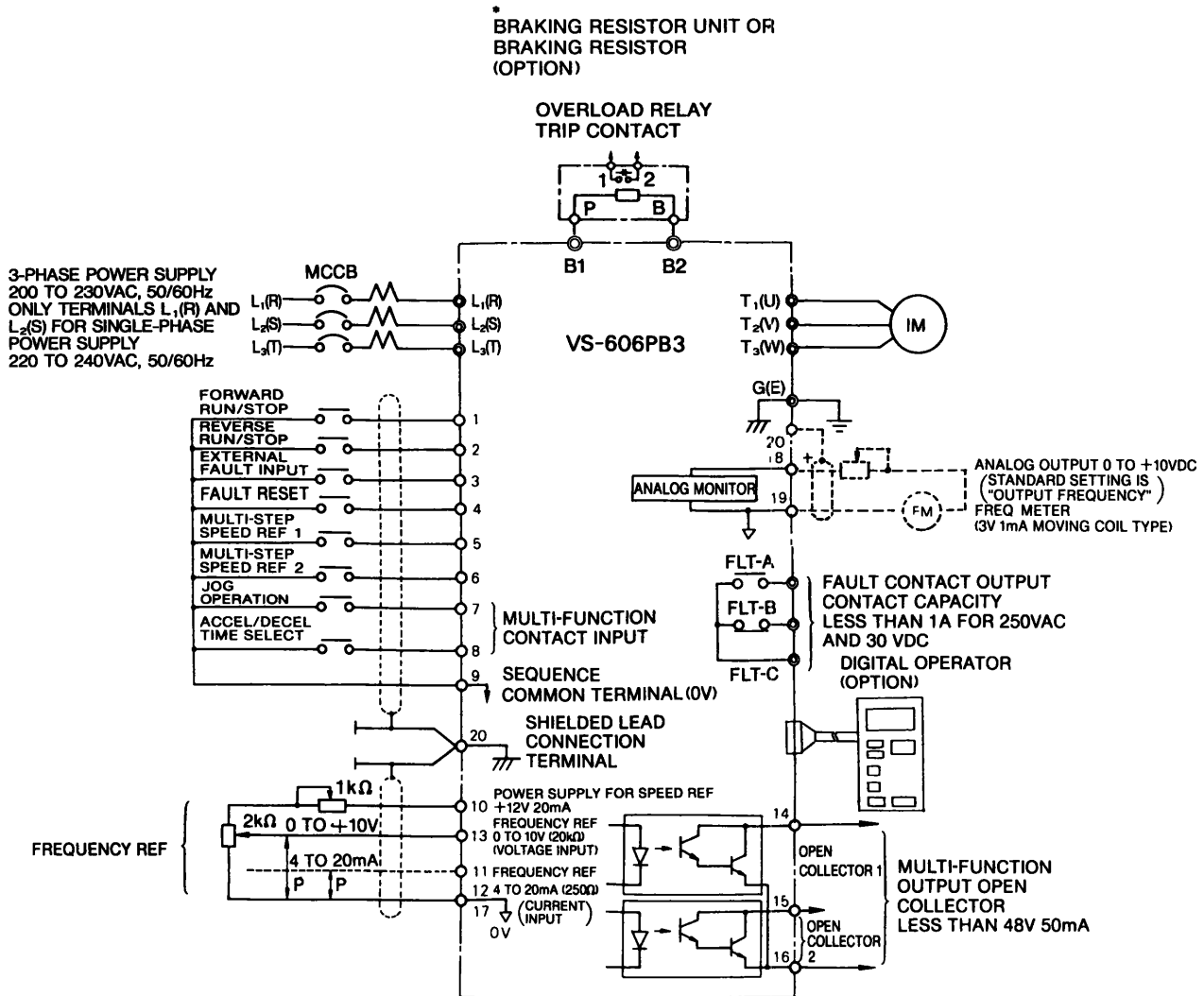
1.8.2 Connection Diagram



Notes:

1.  indicates shielded leads and  twisted-pair shielded leads.

2. External terminal (10) of +12V has maximum output current capacity of 20mA.

3. Terminal symbols: ⊙ shows main circuit; ○ shows control circuit.

4. Control circuit terminals ① and ③ reference values are added in the inverter.

* Set overload relay when using braking resistor (type ERF-150WJ).

Also, use sequencer to break power supply side on overload relay trip contact when using braking resistor or braking resistor unit.

1.8.3 Terminals

• MAIN CIRCUIT

Terminal	Description
L1(R)	Main circuit power input “L1”, “L2” are used for single-phase input specifications
L2(S)	
L3(T)	
T1(U)	Inverter output
T2(V)	
T3(W)	
B1	Braking resistor or braking resistor unit connector
B2	
FLT-A	Contact capacity for fault signal output “Closed” between A and C at fault “Open” between B and C at fault 250VAC 1A or less 30VDC 1A or less
FLT-B	
FLT-C	
G(E)	Grounding (ground resistance should be 100 ohms or less)

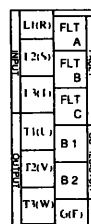
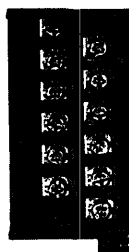

3-phase

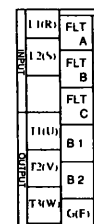

Single-phase

Main Circuit Terminals

• CONTROL CIRCUIT (FACTORY SETTING PRIOR TO SHIPPING)

Classification	Terminal	Signal Function	Description	Signal Level	
Sequence Input Signal	1	Forward operation-stop signal	Forward run when closed stop when open *	Photo-coupler insulation input +24 VDC 8mA	
	2	Reverse operation-stop signal	Reverse run when closed stop when open *		
	3	External fault input	Fault when closed normal when open *		
	4	Fault reset input	Reset when closed *		
	5	Multi-step speed ref 1	Effective when closed		
	6	Multi-step speed ref 2	Effective at "closed"		
	7	Jog command	Jog run when closed		Multifunction contact input two signals available to select *1
	8	Accel/decel time select	Second accel/ decel time effective when closed		
		9	Sequence control input common terminal		-
Analog Input Signal	10	Power supply terminal for speed ref	Speed ref power supply	+12V (Allowable current 20mA max)	
	13	Frequency ref	0 to +10V/100% freq	0 to +10V (20kΩ)	
	11		4 to 20mA/100% freq	4 to 20mA (250kΩ)	
	12	17	Common terminal for control circuit	0V	-
		20	Connection to shield sheath of signal lead	-	-
Sequence Output Signal	14	During running	*L level when running	Multifunction contact output two signals available to select *2 Open collector output +48V 50mA or less	
	15	Frequency agreed signal	*L level when set freq = output freq is obtained		
	16	Open collector output common			
Analog Output Signal	18	Frequency meter	0 to 10V/ maximum output frequency Possible to select current meter output *3	0 to 11V max 2mA or less	
	19	Common			



691 231

Control Circuit Terminals

*1 For details, refer to “MULTIFUNCTION CONTACT INPUT FUNCTION SELECTION” on page 52

*2 For details, refer to “MULTIFUNCTION CONTACT OUTPUT FUNCTION SELECTION” on page 53

*3 For details, refer to “FREQUENCY / CURRENT METFR CALIBRATION” on page 53

1.8.4 Dimensions in inches (mm)

(1) CIMR-PBA20P2T TO -PBA21P5T, CIMR-PBAB0P2T TO -PBAB1P5T [0.25 TO 2HP (0.2 TO 1.5kW)]

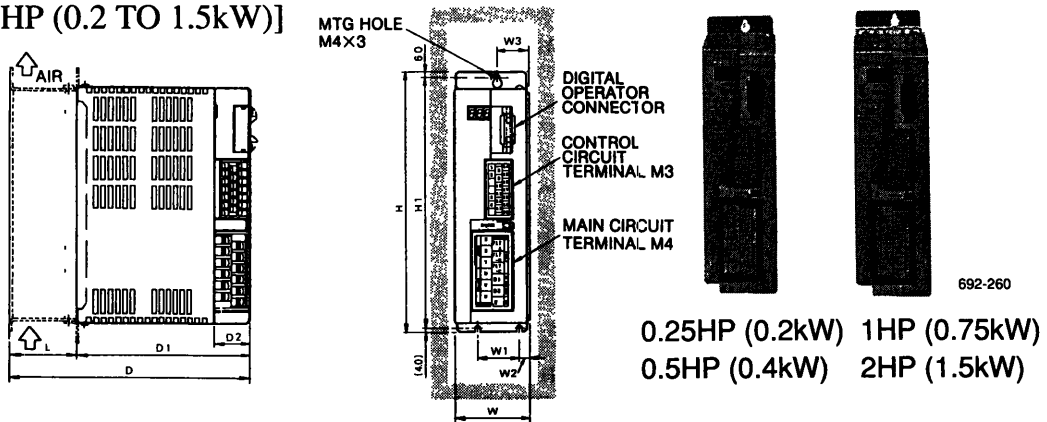

(2) CIMR-PBA22P2T, -PBA23P7T, CIMR-PBAB2P2T, -PBAB3P7T [3/5HP (2.2/3.7kW)]

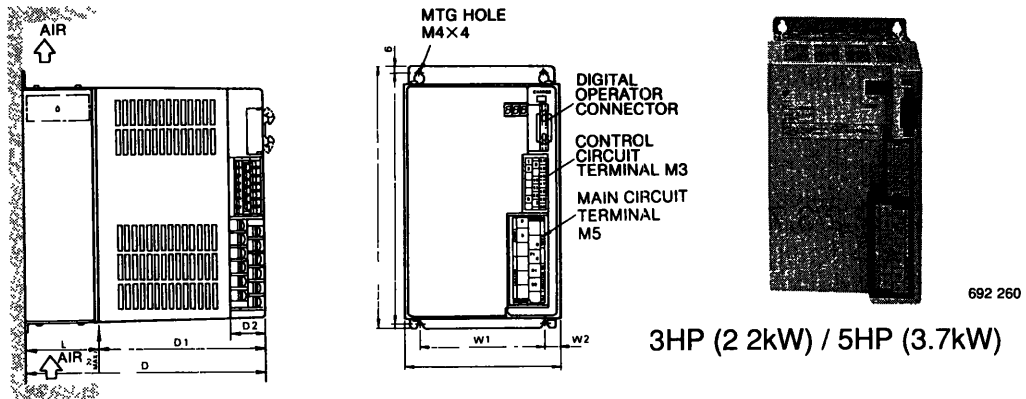

Max Applicable Motor Output HP (kW)	Dimensions in inches (mm)									
	W	W1	W2	W3	H	H1	D	D1	D2	L
0.25/0.5 (0.2/0.4)	2.8(70)	1.6(40)	0.4(10)	1.2(30)	9.9(250)	9.5(240)	6.9(174)	6.9(174)	1.4(33)	—
1/2 (0.75/1.5)	2.8(72)	1.6(40)	0.4(10)	1.2(30)	9.9(250)	9.5(240)	9.1(230)	6.6(167)	1.4(33)	2.5(63)
3/5 (2.2/3.7)	5.9(150)	4.7(120)	0.6(15)	—	9.9(250)	9.5(240)	9.1(230)	6.5(165)	1.4(33)	2.6(65)

Panel drilling plan for mounting cooling fin outside the board

(1) 1/2HP (0.75/1.5kW)

(2) 3/5HP (2.2/3.7kW)

(FOR USE OF ATTACHMENT (OPTION))

Panel Cutout Size

Packing Size

Panel Cutout Size

Packing Size

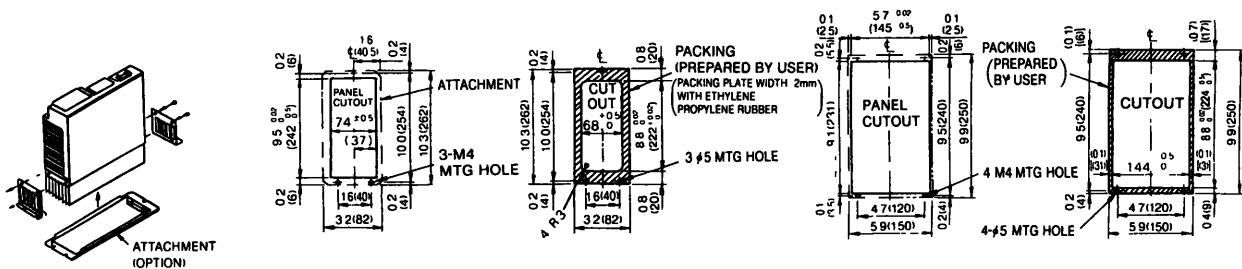

* Contact your Yaskawa representative

- Mounting Procedures for Cooling Fins Outside the Board (mounting on control board of enclosed type)

(1) 1/2HP (0.75/1.5kW) [Optional attachment (code No. SPAT 32903) is needed.]

Mounting Procedure for Attachment

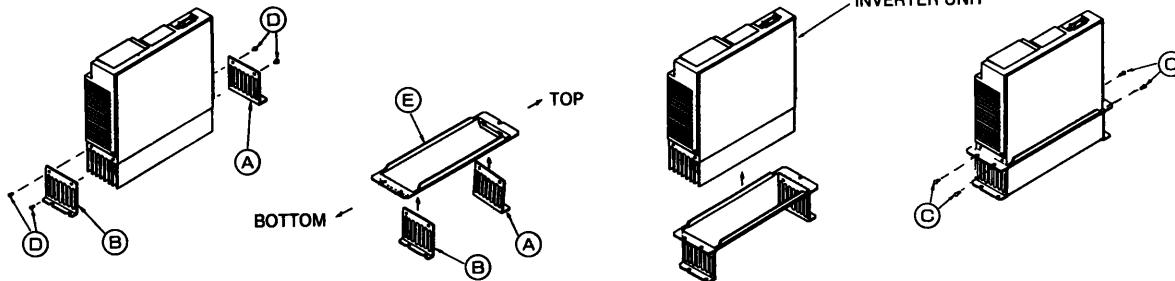

- ① Remove four screws ① on the lower part of the inverter unit, and remove inverter unit mounting legs ② and ③ .
- ② As shown above, insert unit mounting legs ④ and ⑤ into the inner side of attachment ⑥ opening. (Mount the mounting legs in the correct position.)
- ③ Mount unit mounting legs ④ and ⑤ described in ② and attachment ⑥ together.
- ④ The procedure is completed by tightening attachment ⑥ and unit mounting legs ④ and ⑤ on the inverter unit with attachment screws ⑦ .

(2) 3/5 HP (2.2/3.7kW)

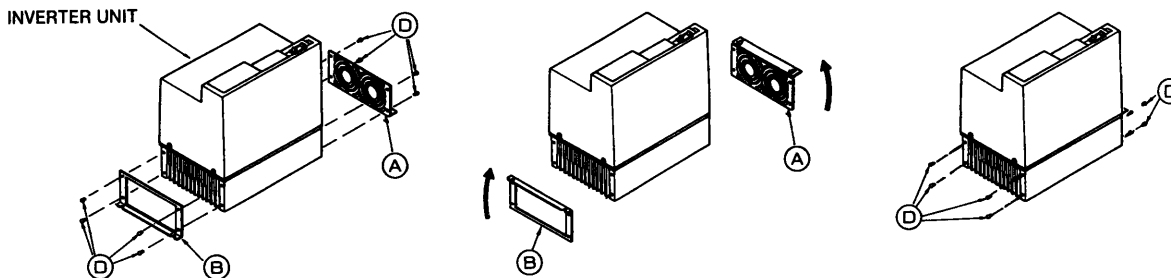

- ① Remove eight screws ① from the inverter unit, and remove unit mounting legs ② and ③ .
- ② As shown above, rotate unit mounting legs ④ and ⑤ by 180°.
- ③ Mount eight screws ① again to complete the procedure.

- Mounting Procedures for Cooling Fins Outside the Board to Enhance Adhesion between Inverter Unit and Panel (mounting on control board of totally-enclosed type)

In addition to above procedures, use packing shown in panel drilling plan. Then apply sealing to adhesive part between attachment [below 2HP (1.5kW)] or unit mounting legs [3/5HP (2.2/3.7kW)] and inverter unit.

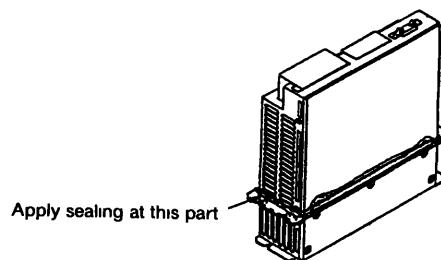

VS-606PB3 Calorific Power

• 3-phase Series

Type CIMR-PBA2□	0P2T	0P4T	0P7T	1P5T	2P2T	3P7T
Inverter Capacity (kVA)	0.7	1.3	2.2	2.8	4.7	7.5
Rated Output Current (A)	1.5	3	5	6.5	11	17.5
Heat Loss (W)	Cooling fin	—	—	25	40	99
	Inner unit	21	35	37	48	37
	Total power	21	35	62	89	136
Fin Cooling Method	Self-cooling			Externally-cooled		

• Single-phase Series

Type CIMR-PBAB□	0P2T	0P4T	0P7T	1P5T	2P2T	3P7T
Inverter Capacity (kVA)	0.7	1.3	2.2	2.8	4.7	7.5
Rated Output Current (A)	1.5	3	5	6.5	11	17.5
Heat Loss (W)	Cooling fin	—	—	25	40	103
	Inner unit	25	43	47	61	49
	Total power	25	43	72	101	152
Fin Cooling Method	Self-cooling			Externally-cooled		

1.8.5 Optional Units

Name	Model (Code No.)	Function	Installing Position	Reference
Digital Operator	JVOP-100 (73041-09100)	Operation sequence, all function selection and constant setting are available. Frequency setting or display of output frequency, output current and faults is also possible.	Separately installed	TOE-C736-50 3
Exclusive Extension Cable for Digital Operator	1m cable (72616-W3001-01) 3m cable (72616-W3003-01)	This extension cable is used when the digital operator is used Length 1m or 3m	—	TOE-C736-50 10
VS Operator (Small Plastic Version)	JVOP-95- * (73041-0905X-)	An exclusive control panel for remotely setting frequency and for turning the unit ON/OFF using analog commands (distance up to 50m). Scale on the frequency indicator. 60/120Hz, 90/180Hz	Separately installed	—
VS Operator (Standard Version)	JVOP-96- * (73041-0906X-)	An exclusive control panel for remotely setting frequency and for turning the unit ON/OFF using analog commands (distance up to 50m). Scale on the frequency indicator: 75Hz, 150Hz, 220Hz	Separately installed	—
Braking Resistor Unit	LKEB- (72600-K 0)	Shortens the motor deceleration time by causing the regenerative energy to be consumed through the resistor.	Separately installed	TOE-C736-50 5
Braking Resistor	ERF-150WJ	Shortens the motor deceleration time by causing the regenerative energy to be consumed through the resistor.	Separately installed	—

* The types of frequency indicators are to be shown in the box after the model name and the number.

Frequency Indicator (max scale)	Model	Code No
75Hz	1	01
150Hz	2	02
220Hz	3	03

1.8.6 Peripheral Units

Name	Model (Code No.)	Function
VS System Module	JGSM-...	Precise and complex drive system control. Available in 15 types.
Frequency Meter	DCF-6A	Provided with VS operator as standard. Available as separate components for remote control from several locations.
Frequency Setting Frequency Meter Adjusting Potentiometer Frequency Setting Knob	—	
Potentiometer	ETX00304 (1k Ω) ETX00305 (20k Ω)	
AC Reactor	UZBA-...	<ul style="list-style-type: none"> •Motor noise reduction. •Starting torque improvement. •For motors exceeding the inverter horsepower.
Radio Noise Protective Filter	HF, LF	Use a radio noise filter to eliminate radio wave interference. It is provided at input terminals of the inverter main circuit.
Molded-case Circuit Breaker (MCCB)	NF	Installation of MCCB at power supply will protect the inverter connection.
Magnetic Contactor (MC)	HI-E	MC is required on inverters using the dynamic braking function.
Surge Absorber	DCR2-...	Absorbs surge currents by opening and closing of magnetic contactors and control relays. Must be installed on magnetic contactors or control relays near the inverter.
Output Voltmeter	SCF-12NH	Voltmeter for PWM inverter.
Isolator	DGP	Isolates the inverter input and output signals to reduce induced noise.

Note : Contact your YASKAWA representative for further information.

2. DIGITAL OPERATOR (JVOP-100) (OPTION)

The digital operator can perform operation sequence, function selection, constant setting, operation status monitor and display of fault contents by connecting it to the inverter by using the exclusive-use extension cable (option).

Function List	Par.	Page
For reading (read-out) or setting (write-in) of functions or constants	2.3	30
For digital operator single-unit operation	2.4	33
For changing set value to factory setting again	2.5.1	34
For function or constant write-in prohibit	2.5.2	34
For adjustment of relation between frequency reference and output frequency	2.6.1	35
For calibration of frequency meter or ammeter (externally connected)	2.6.2	36
For monitor function use	2.7	37

2.1 INSTALLATION

There are two installation methods for the digital operator : Connecting exclusive extension cable for hand operation and mounting on the housing panel.

The digital operator can be installed or removed while current is applied or during run.

(1) Handy operation by extension cable

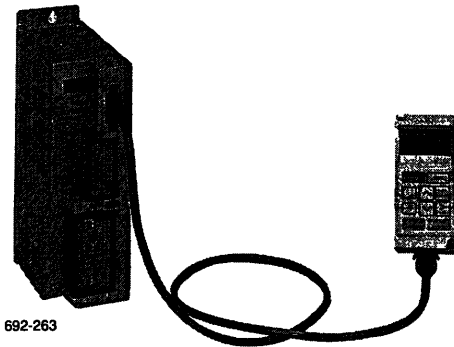

- Make sure to mount the cable on the inverter.

(2) Mounting on housing panel

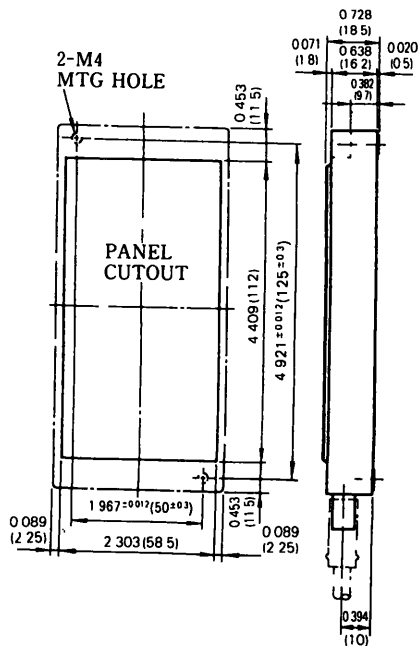

- Cut the housing panel and mount the operator shown on the left.

Note: Do not use any other cables than the exclusive extension cables.

Two types of cables are available: 1m and 3m long.
(Refer to Par. 1 8.5 “ Optional Units ” on page 25.)

2.2 DESCRIPTION OF DIGITAL OPERATOR DISPLAY AND OPERATING SECTIONS

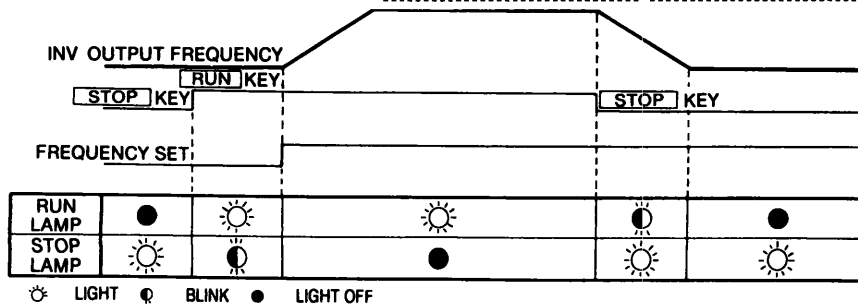
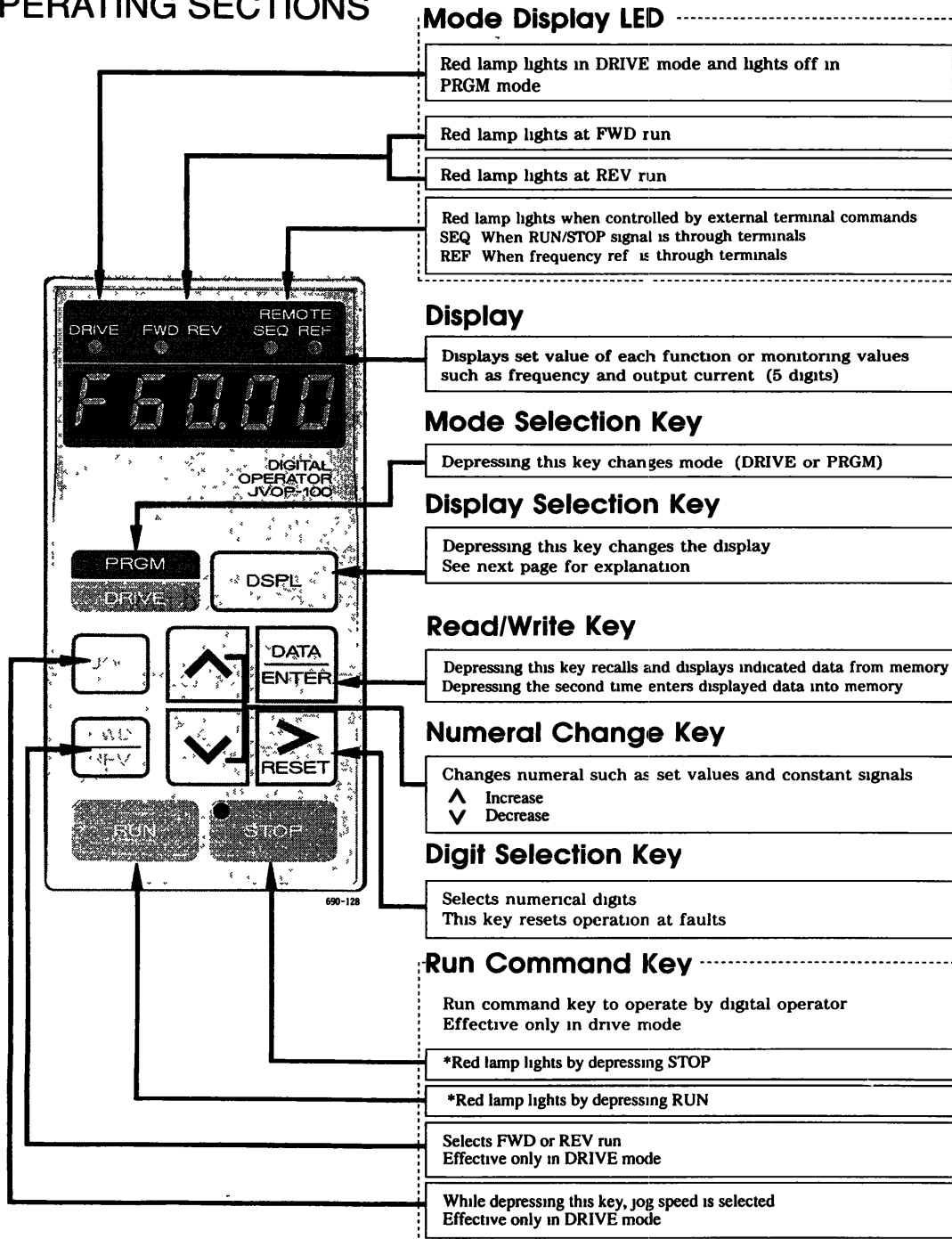

* RUN or STOP lamp changes in accordance with the operations.

2.3 FUNCTION/CONSTANT SETTING

DRIVE MODE AND PRGM (PROGRAM) MODE

Selection of DRIVE mode or PRGM mode can be performed by using the **PRGM/DRIVE** key when the inverter is stopped. When function selection or a change of set value is required, switch to the PRGM mode.

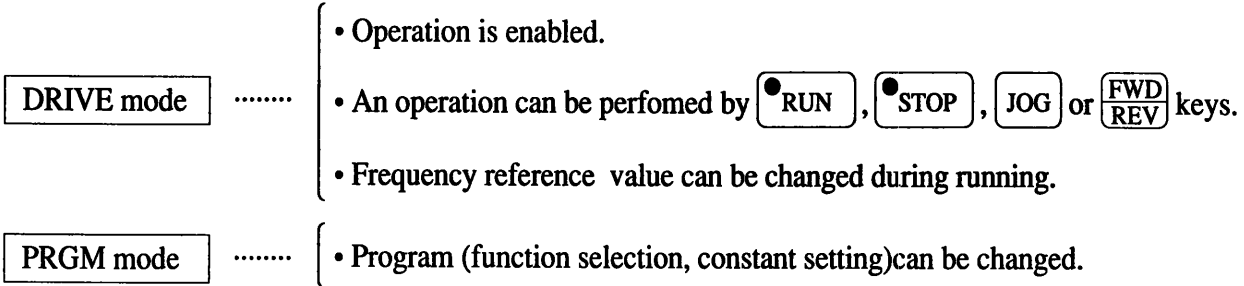

Display Contents of DRIVE Mode and PRGM Mode

- Display contents of the digital operator differ according to selected mode (PRGM/DRIVE).
- The constant group to be displayed is changed each time display selection key **DSPL** is depressed.
- If a fault occurs, the contents are displayed. Additionally, since the contents of the latest fault are stored, maintenance, inspection or troubleshooting can be performed quickly by checking the contents by the digital operator.

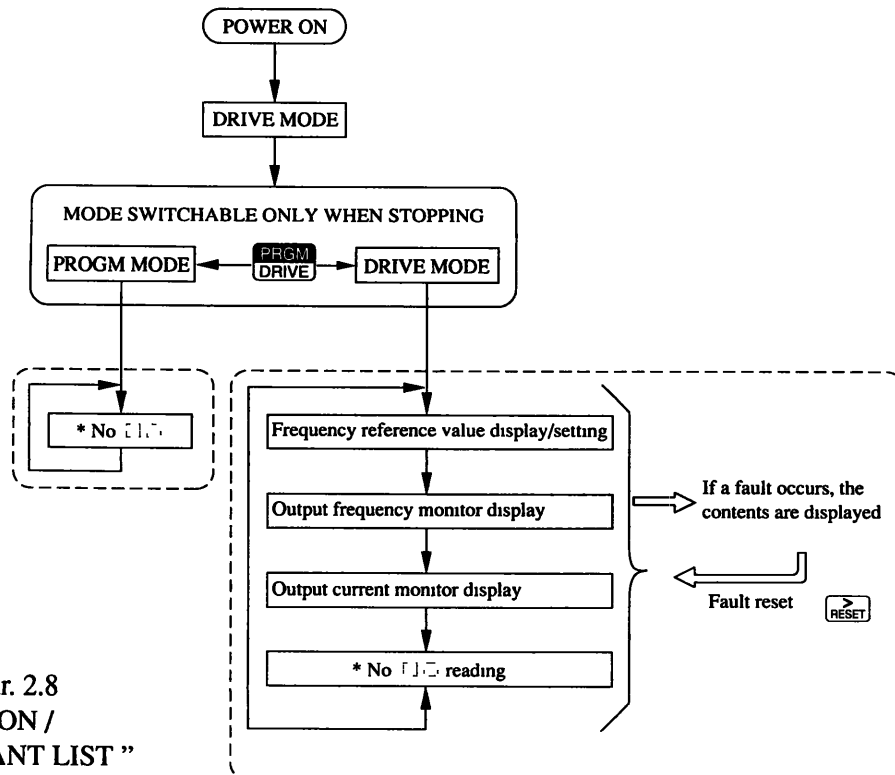

* Refer to Par. 2.8
“FUNCTION /
CONSTANT LIST”

• Constant Reading and Setting

The VS-606PB3 has various functions for the optimum operation. Use it with the set values according to the load conditions or operation conditions of the matching machine. Set values are read or set by the digital operator. Set constant (No.00) as follows :

- (1) 1st functions (constant No. 00 to 19) can be set / read : No. 00 = 1 (Factory setting)
- (2) 1st and 2nd functions (constant Nos. 00 to 29) can be set / read : No. 00 = 2
- (3) 1st, 2nd and 3rd functions (constant Nos. 00 to 59) can be set / read : No. 00 = 3

<Typical setting>

- The following shows an example where acceleration time (No. 09) is changed from 10 seconds to 5 seconds.
- Other constants can be changed in the same operation.

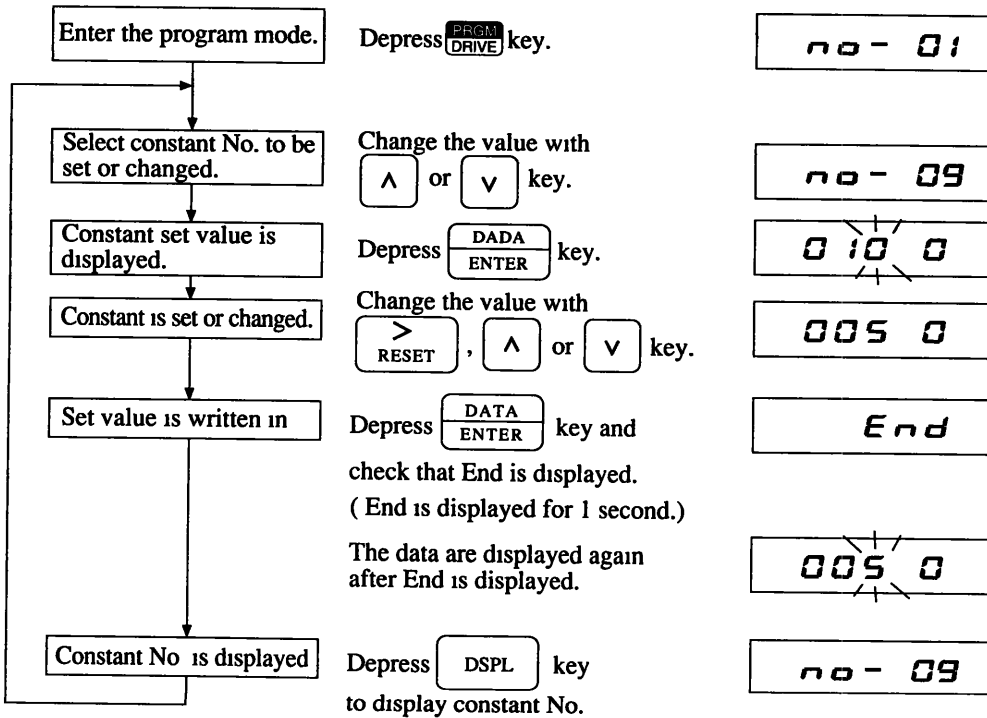

Note: Check that **End** is displayed for each constant setting. Constants cannot be changed simultaneously.

• Precautions on Constant Setting

In the following cases, the set value blinks for 3 seconds and the data before changing are returned.

1. When a value exceeding the setting range is set
2. If the following condition is not satisfied in the multifunction input selection constant setting :
Multifunction input selection 1 (No. 32) \geq Multifunction input selection 2 (No. 33)
3. If the following conditions are not satisfied in the V/f constant setting:
Maximum frequency (No. 02) \geq Max. voltage frequency (No. 04) $>$ Mid. frequency (No. 05) \geq Minimum output frequency (No. 07)
For the following setting, mid. frequency voltage (No. 06) is disregarded:
Mid. frequency = Minimum frequency.
For details, refer to “V/f CHARACTERISTIC SETTING” on page 45.
4. If the following condition is not satisfied in the frequency reference constant setting:
Set frequency reference (Nos.13 to 17, 41 to 44) \leq Maximum frequency (No. 2).
For details, refer to “V/f CHARACTERISTIC SETTING” on page 45.
5. If the following condition is not satisfied in the frequency reference upper / lower limit value setting :
Frequency reference lower limit value (No. 25)
 \leq Frequency reference upper limit value (No. 24)

2.4 DIGITAL OPERATOR OPERATION EXAMPLE

The following shows an example of digital operator operation.

Operation Pattern

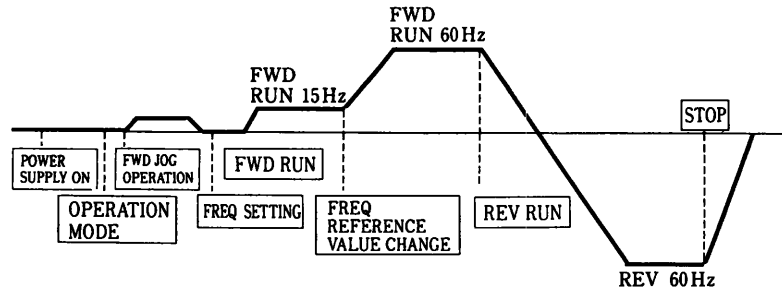

Operation

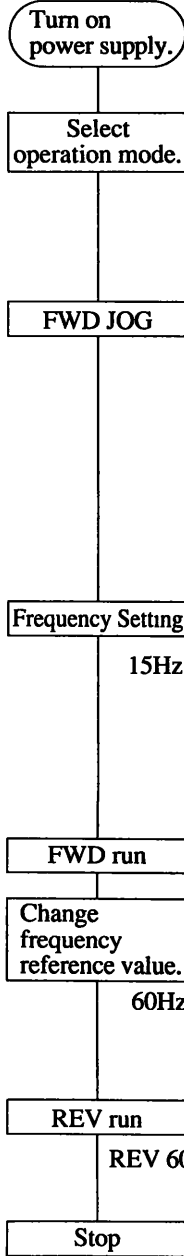

[Description] [Key Operation] [Digital Operator Display]

- Frequency reference value is displayed.
- Select PRGM mode.
- Select digital operator operation.
- Change constant (No.01) to 0011.
- Set value is written in.
- Change to DRIVE mode.
- Frequency reference value is displayed.
- Select output frequency monitor display. (option)
- Check direction of rotation. (FWD is default on power on.)
- Jog operation (while key is depressed)

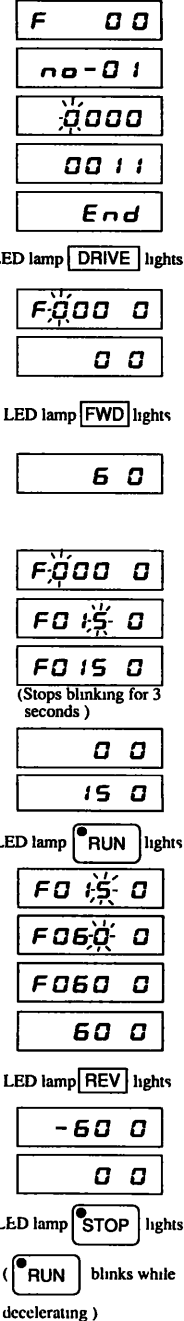
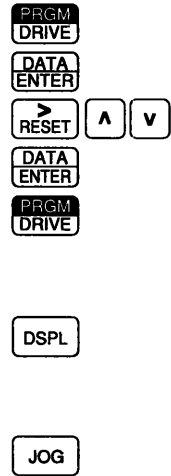

- Frequency reference value display is selected
- Change reference value
- Set value is written in. (Stops blinking for 3 seconds.)
- Select output frequency monitor display.
- Running operation.
- Select frequency reference value display.
- Change reference value.
- Write in set value (stops blinking for 3 seconds).
- Select output frequency monitor display.
- Change to REV run.
- Decelerating to stop

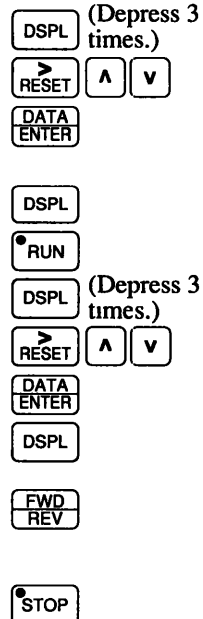

2.5 CONSTANT INITIALIZATION AND WRITE IN PROHIBIT

2.5.1 Constant Initialization (Operation to return to factory setting)

- Write in 8 to constant (No. 00).

[Description]	[Key Operation]	[Digital Operator Display]
•Select PRGM mode.		
•Select constant (No. 00).		
•Constant (No. 00) is displayed.		*1
•Change the set value.		
•Write in the set value. (End is displayed for 1 second.) The data are displayed again after End is displayed.		
		*2

*1: Differs according to the setting data before changing.

*2: The display returns to after write-in. This indicates that initialization is executed at writing in the data.

2.5.2 Constant Write in Prohibit (Only constant reading possible)

- The following shows an example where 0 is written in to constant (No. 00) [password (No.00) setting / reading and the first functions (constant Nos. 01 to 19) reading enabled].

[Description]	[Key Operation]	[Digital Operator Display]
•Select PRGM mode.		
•Select constant (No.00).		
•Constant (No.00) is displayed.		*
•Change the set value.		
•Write in the set value. (End is displayed for 1 second.) The data are displayed again after End is displayed.		

* Differs according to setting data before changing.

2.6 CORRECTIVE FUNCTION

2.6.1 Adjustment of Frequency Setting Value, Output Frequency Bias (No. 23) and Gain (No. 22)

Any desired value of output frequency for frequency set value (0 to 10V or 4 to 20mA) can be set.

<Example> Adjust so as to obtain 10% speed (6Hz) at frequency setting voltage 0V and 100% speed (60Hz) at 8V
[Set constant (No. 23) = 0.10 and constant (No. 22) = 1.23.]

[Description] [Key Operation] [Digital Operator Display]

•Select PRGM mode.	PRGM DRIVE	<code>no-01</code>
<Bias>		
•Select constant (No 23).	^	<code>no-23</code>
•Data (No 23) are displayed	DATA ENTER	<code>0 00</code>
•Change the set value	> RESET ^ v	<code>0 10</code> (10% = 0 1)
•Write in the set value. (End is displayed for 1 second) The data are displayed again after End is displayed.	DATA ENTER	<code>End</code> <code>0 10</code>

 <Gain>

•Select constant (No 22)	DSPL v	<code>no-22</code>
•Data (No. 22) are displayed.	DATA ENTER	<code>1 00</code>
•Change the set value.	> RESET ^ v	<code>1 23</code> *
•Write in the set value. (End is displayed for 1 second) The data are displayed again after End is displayed	DATA ENTER	<code>End</code> <code>1 23</code>

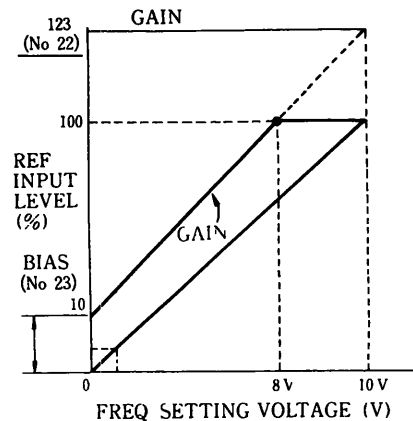

* How to calculate gain

$$x = \frac{100 - b}{a} \dots\dots (1)$$

x can be obtained by equation (1).

$$x = \frac{100 - 10}{8} = 11.25$$

Then by substituting x obtained in equation (1) for equation (2) to obtain G :

$$G = \frac{10x + b}{100} \dots\dots(2)$$

$$G = \frac{10 \times 11.25 + 10}{100} = 1.225$$

$$= 1.23$$

- a : Setting voltage at 100% frequency (V)
In this example, since 100% speed (60Hz) is obtained at 8V, a = 8.
- b . Bias level (%)
In this example, 10% speed (6Hz) is obtained at frequency setting voltage 0V, b = 10.
- G: Gain set value
In this example, it is 1.23.

2.6.2 Calibration of Frequency Meter

Calibration of frequency meter or ammeter connected to the inverter can be performed even without providing a calibration resistor.

<Example> When the frequency meter specifications are 3V (1mA) full-scale, 3V full-scale output is used at maximum output [constant (No.02)] operation. [Set constant (No. 45) = 0.30.]

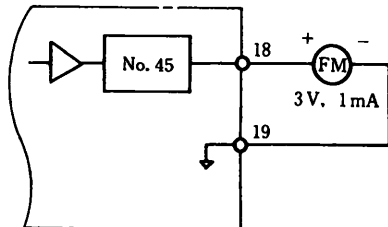

Frequency Meter Calibration

[Description]	[Key Operation]	[Digital Operator Display]
•Select PRGM mode	PRGM DRIVE	no-01
•Select constant (No.45).	DSPL ▲ ▼	no-45
•Data are displayed.	DATA ENTER	1.00
•Change the set value.	➤ RESET ▲ ▼	0 30 ...10V×[0.3]=3.0V *
•Write in the set value.(End is displayed for 1 second.)	DATA ENTER	End
The data are displayed again after End is displayed.		0 30

* Since analog monitor gain is set to 1.00 prior shipping, 10V is output at maximum output frequency [constant (No. 02)] operation.

Note : By data display of constant (No. 45) in the program mode, voltage at 100% level according to the constant (No. 45) set value is output by the meter calibrating function without any conditions.

(Example) Assuming constant (No. 45) = 0.30 : $100V \times 0.30 = 3V$ is output without any conditions.

2.7 MONITOR

Frequency reference value, output frequency, output current and fault contents can be monitored.

- Typical Monitor Contents and Display (DRIVE Mode)

The monitor item is changed every time when the  key is depressed.

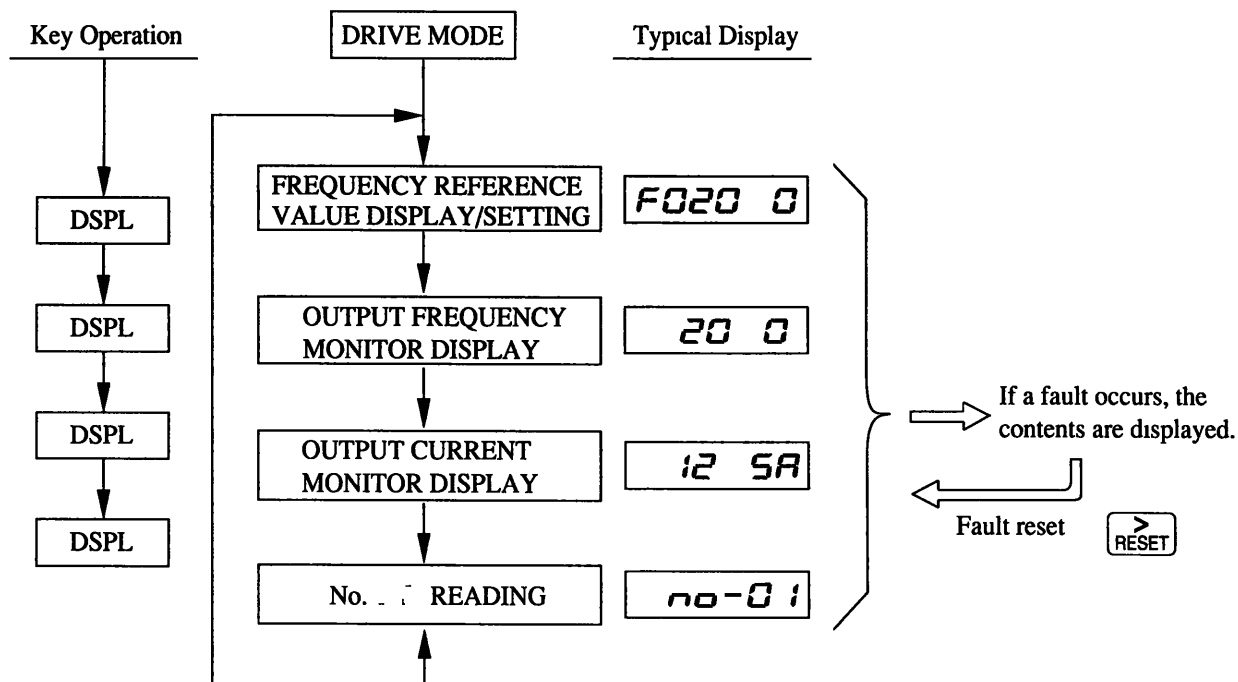

Monitoring of Fault Contents

- If a fault occurs, the fault contents are displayed with priority over other display items. Depress the  key or turn on the fault reset input signal to reset the fault.
- Since the latest fault content data are stored in the inverter, even if the power supply is turned off, they can be monitored after the power supply is turned on again.

(1) Checking fault contents

The latest data are stored in the constant (No. 48). (except U_L)

(2) Clearing fault contents

The contents are cleared by setting “6” to the constant (No.00).

Or they are also cleared by constant initialization. [Set constant (No. 00) = 8 or 9.]

At this time, other constants are changed to the factory setting values. Therefore, record all of the constant data before initializing constant.

(3) Faults to be stored

OC (overcurrent), GF (ground fault), OV (overvoltage), OH (cooling fin overheat), OL1 (motor overload), OL2 (inverter overload), OL3 (overtorque detection), EF3 (external fault), CPF05 (AD converter fault), CPF07 (thermistor fault) For details, refer to Table 5 “Fault Display and Contents” on page 17.

Note: GF (ground fault) is detected only in model CIMR-PBE.

2.8 FUNCTION/CONSTANT LIST

(1) First Functions (Constant Nos. 00 to 10)

Function	No.	Name	Description	Initial Setting	Use Set Values	Reference Page
Constant Group Selection	00	Password	0: Password (No. 00) setting/reading and first function (constant Nos. 01 to 19) reading possible 1: First function (constant Nos. 00 to 19) setting/reading possible 2: First and second functions (constant Nos. 00 to 29) setting/reading possible 3: First, second and third functions (constant Nos. 00 to 59) setting/reading possible 6: Fault record clear 8: Initialize (multifunction terminal: initial value setting) 9: Initialize (3-wire sequence)	1		43
Fault Contents Clear						
Constant Initialization						
Operation Method Selection	01 *3	Run Signal Selection 1	1st digit =0: Master frequency reference-External terminals 11 and 13 inputs =1: Master frequency reference-Operator F × × × × 2nd digit=0: Run by external terminal run command 1: Run by operator run command 3rd digit =0: Deceleration to a stop 1: Coasting to a stop	0000		43
Stopping Method Selection		Output Voltage Limiter Selection	4th digit: 0: Free choice V/f with output voltage limiter 1: Free choice V/f without output voltage limiter			
V/f Pattern Setting	02	Maximum Output Frequency	Setting unit: 0.1Hz, Setting range: 50.0 to 400.0Hz	60 0Hz		45
	03	Maximum Voltage	Setting unit: 0.1V, Setting range: 0.1 to 255.0V	200 0V		
	04	Maximum Voltage Output Frequency (Base Frequency)	Setting unit: 0.1Hz, Setting range: 0.2 to 400.0Hz	60 0Hz		
	05	Mid. Output Frequency	Setting unit: 0.1Hz, Setting range: 0.1 to 399.9Hz	1 5Hz		
	06	Mid. Output Frequency Voltage	Setting unit: 0.1V, Setting range: 0.1 to 255.0V	12.0V		
	07	Minimum Output Frequency	Setting unit: 0.1Hz, Setting range: 0.1 to 10Hz	1 5Hz		
	08	Minimum Output Frequency Voltage	Setting unit: 0.1V, Setting range: 0.1 to 50V	12 0V		
	First Accel/decel Time Setting	09	Acceleration Time 1	Setting unit: 0.1s, Setting range: 0.0 to 600.0s	10.0s	
10		Deceleration Time 1	Setting unit: 0.1s, Setting range: 0.0 to 600.0s	10 0s		

(2) Second Functions (Constant Nos. 20 to 29)

Function	No.	Name	Description	Initial Setting	User Set Values	Reference Page															
REV Run Prohibit	20	Run Signal Selection 2	1st digit = 0: REV run enabled = 1: REV run disabled	0000		43															
Operator Stop Key Precedence			2nd digit = 0: STOP key effective = 1: STOP key ineffective			—															
External Fault Input Selection			3rd digit = 0: External fault (control terminal 3) - NC contact input = 1: External fault (control terminal 3) - NC contact input			—															
Stall Prevention during Deceleration			4th digit = 0: Stall prevention during deceleration provided = 1: Stall prevention during deceleration not provided (when braking resistor connected)			51															
Inverter Display Unit Monitor Content Selection	21	Output Monitor Selection	1st digit = 0: Digital display - output frequency display = 1: Digital display - output current display	0000		49															
Analog Monitor Selection			2nd digit = 0: Analog monitor - output frequency = 1: Analog monitor - output current (Analog monitor gain is set by constant No. 45.)			—															
—		S-curve Accel / decel Selection	3rd, 4th digit				57														
			<table border="1"> <thead> <tr> <th>S-curve Accel / decel Selection</th> <th>Not provided</th> <th>0.2 sec</th> <th>0.5 sec</th> <th>1.0 sec</th> </tr> </thead> <tbody> <tr> <td>3rd Digit</td> <td>0</td> <td>1</td> <td>0</td> <td>1</td> </tr> <tr> <td>4th Digit</td> <td>0</td> <td>0</td> <td>1</td> <td>1</td> </tr> </tbody> </table>	S-curve Accel / decel Selection	Not provided	0.2 sec	0.5 sec	1.0 sec	3rd Digit	0	1	0	1	4th Digit	0	0	1	1			
S-curve Accel / decel Selection	Not provided	0.2 sec	0.5 sec	1.0 sec																	
3rd Digit	0	1	0	1																	
4th Digit	0	0	1	1																	
	22	Frequency Reference Gain	Setting unit: 0.01, setting range: 0.01 to 2.00	1.00		47															
	23	Frequency Reference Bias	Setting unit: 0.01, setting range: -1.00 to 1.00	0.00		47															
Frequency Limit Control	24	Frequency Upper Limit	Setting unit: 1%, setting range: 0 to 110%	100%		50															
	25	Frequency Lower Limit	Setting unit: 1%, setting range: 0 to 110%	0%																	
DC Injection Braking	26	DC Injection Braking Current	Setting unit: 1%, setting range: 0 to 100% of inverter rated current	50%		50															
	27	DC Injection Braking Time at Stop	Setting unit: 0.1s, setting range: 0.0 to 5.0s	0.5s																	
	28	DC Injection Braking Time at Start	Setting unit: 0.1s, setting range: 0.0 to 5.0s	0.0s																	
Torque Compensation	29	Automatic Torque Boost Gain	Setting unit: 0.1, setting range: 0.0 to 3.0	1.0		51															

(3) Third Functions (Constant Nos. 30 to 39)

Function	No.	Name	Description	Initial Setting	User Set Values	Reference Page
Stall Prevention	30	Stall Prevention Level during Acceleration	Setting unit: 1%, setting range : 30 to 200% of inverter rated current Note: Stall prevention is not performed during acceleration when 200% is set.	170%		51
	31	Stall Prevention Level during Running	Setting unit: 1%, setting range : 30 to 200% of inverter rated current Note: Stall prevention is not performed during run when 200% is set.	160%		
Multifunction Selection	Contact Input Signal	32	Multifunction Input Selection 1 (Terminal 7 Function Selection) 0: FWD/REV run command (3-WIRE sequence selection) 1: JOG command 2: Accel/decel time select, 3: Multi-step speed reference 3 4: External baseblock (NO contact input) 5: External baseblock (NC contact input) 6: Speed Search from maximum frequency 7: Speed Search from set frequency 8: Accel / Decel hold (Output frequency constant)	1		52
		33	Multifunction Input Selection 2 (Terminal 8 Function Selection) 1: JOG command 2: Accel/decel time select 3: Multi-step speed reference 3 4: External baseblock (NO contact input) 5: External baseblock (NC contact input) 6: Speed Search from maximum frequency 7: Speed Search from set frequency 8: Accel / Decel hold (Output frequency constant)	2		
	Photocoupler Output Signal	34	Multifunction Output Selection 1 (Terminal 14 Function Selection) 0: Running 1: Agreed frequency 2: Zero speed 3: Frequency detection (output frequency \geq frequency detection level) 4: Overtorque detection	0		53
35		Multifunction Output Selection 2 (Terminal 15 Function Selection) 0: Running 1: Agreed frequency 2: Zero speed 3: Frequency detection (output frequency \geq frequency detection level) 4 Overtorque detection	1			
Desired Speed Detection	36	Frequency Detection Level	Setting unit: 0.1Hz, setting range: 0.0 to 400.0Hz	0.0Hz		56
Overtorque Detection	37	Overtorque Detection Function Selection	1st digit = 0: Overtorque detection not provided = 1: Overtorque detection provided	0000		54
			2nd digit = 0: Detected only during agreed frequency = 1: Detected during running			
			3rd digit = 0: Operation continues after overtorque detection = 1: Output shut-off at overtorque detection			
			4th digit: Not used			
	38	Overtorque Detection Level	Setting unit: 1%, setting range 30 to 200%	160%		
	39	Overtorque Detection Time	Setting unit: 0.1s, setting range. 0.1 to 10.0s	0.1s		

(3) Third Functions (Constant Nos. 40 to 59) (Cont'd)

Function	No.	Name	Description	Initial Setting	User Set Values	Reference Page
Carrier Frequency Adjustment	40	Carrier Frequency	Setting unit : 1, Setting range : 1 to 6 (2.5 to 15Hz)	4 (10kHz)		55
Multi-step Speed Frequency Reference*	41	Frequency Reference 5	Setting unit : 0.1Hz, Setting range : 0.0 to 400.0Hz	0.0Hz		46
	42	Frequency Reference 6	Setting unit : 0.1Hz, Setting range : 0.0 to 400.0Hz	0.0Hz		
	43	Frequency Reference 7	Setting unit : 0.1Hz, Setting range : 0.0 to 400.0Hz	0.0Hz		
	44	Frequency Reference 8	Setting unit : 0.1Hz, Setting range : 0.0 to 400.0Hz	0.0Hz		
Analog Monitor Scale Calibration	45	Analog Monitor Gain	Setting unit : 0.01, Setting range : 0.01 to 2.00	1.00		49
Momentary Power Loss Protection	46	Operation Selection after Momentary Power Loss	1st digit = 0 : Continuous operation after momentary power loss not provided = 1 : Continuous operation after momentary power loss provided 2nd, 3rd, 4th digit = Not used.	0000		60
Fault Retry	47	Fault Retry	Setting unit : 1 time, Setting range : 0 to 10 times Note : By setting 0 times, fault retry function becomes disabled.	0		61
Fault Trace	48	Fault Record	The latest fault is displayed (setting disabled).	—	—	—
Software Version	49	PROM No.	PROM No. is displayed (setting disabled).	—	—	—
Prohibited Frequency Control	50	Prohibited Frequency 1	Setting unit : 0.1Hz Setting range : 0.0 to 400.0Hz	0.0Hz		58
	51	Prohibited Frequency 2	Setting unit : 0.1Hz Setting range : 0.0 to 400.0Hz	0.0Hz		
	52	Prohibited Frequency 3	Setting unit : 0.1Hz Setting range : 0.0 to 400.0Hz	0.0Hz		
	53	Prohibited Width	Setting unit : 0.1Hz Setting range : 0.0 to 25.5Hz	1.0Hz		
Speed Search Control	54	Speed Search Motion Level	Setting unit : 1% Setting range : 0 to 200% of inverter rated current	150%		59
	55	Minimum Baseblock Time	Setting unit : 0.1s Setting range : 0.5 to 5.0s	0.5s		
	56	V/f during Speed Search	Setting unit : 1% Setting range : 0 to 100%	100%		
—	57	Not Used				
	58	Not Used				
	59	Not Used				

* Can be changed even during run.

2.9 DESCRIPTION OF FUNCTIONS AND CONSTANTS

Constant Nos. are indicated as \boxed{N} .

PASSWORD SETTING

Item Name	Constant to be Set	Factory Preset
Constant group selection	$\boxed{0}$	1

- $\boxed{0}=0$
Password $\boxed{0}$ setting / reading and the first function ($\boxed{0}$ to $\boxed{19}$) reading are enabled.
This setting prevents constant from being re-set by improper operation after completion of constant setting.
 $\boxed{0}$ can be written in.
- $\boxed{0}=1$ The first functions ($\boxed{0}$ to $\boxed{19}$) can be set and read.
- $\boxed{0}=2$ The first and second functions ($\boxed{0}$ to $\boxed{29}$) can be set and read.
- $\boxed{0}=3$ The first, second and third functions ($\boxed{0}$ to $\boxed{59}$) can be set and read.

OPERATION MODE SELECTION

Item Name	Constant to be Set	Factory Preset
Start/stop procedure	$\boxed{1}$	0000
Reverse rotation prevention	$\boxed{20}$	0000

- **Start procedure**
Operation can be performed from the operator or control circuit terminal input.

$\boxed{1} = \times \times 0 0$ (\times means 1 or 0.)

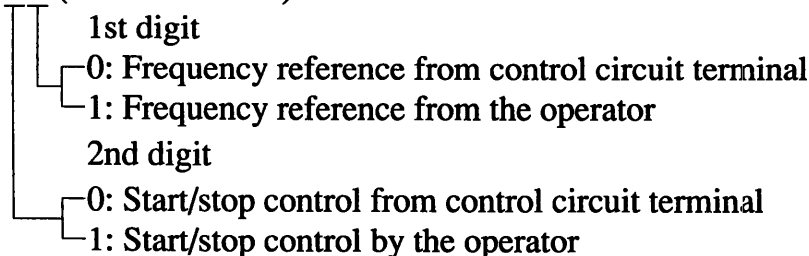

- Stop procedure

Stopping mode can be selected according to the application.

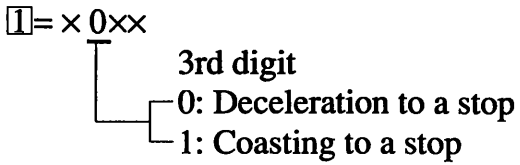

- Reverse rotation prevention

Prevents accidental selection of reverse rotation.

REV run command is disregarded if input.

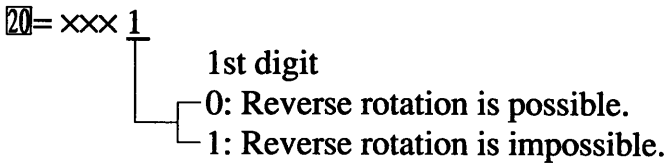

Note: The first to fourth digits indicated in the description of the constant mean the following digits.

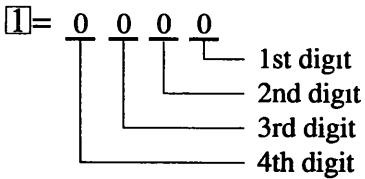

V/f CHARACTERISTICS SETTING

Item Name	Constant to be Set	Factory Preset
Max. output frequency	2	60.0Hz
Max. voltage	3	200.0V
Max. voltage output frequency	4	60.0Hz
Mid. output frequency	5	1.5Hz
Mid. output frequency voltage	6	12.0V
Min. output frequency	7	1.5Hz
Min. output frequency voltage	8	12.0V
Output voltage limiter selection	1	0000

V/f pattern setting

Any desired V/f pattern can be set for special specifications, too.

Any V/f pattern can be set according to the load characteristics. The factory preset value is set to 60Hz saturation type pattern.

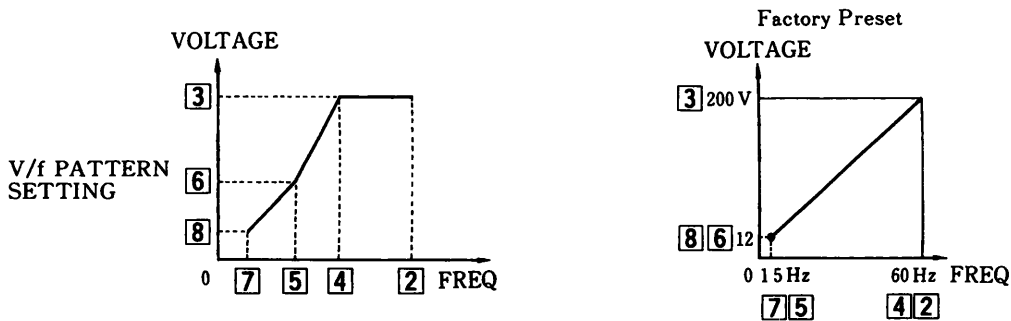

Note: If an excessively large value is set in low-speed area (3Hz or less), motor overheat or inverter malfunction may occur.

Output limiter selection

When V/f is set to excessively large value, an inverter fault may occur. Therefore, in order to prevent malfunction, the upper limit is provided for the output voltage. However, the setting is not necessary under normal operation.

1 = 0 xxx

4th digit

0: Desired V/f with output voltage limiter

1: Desired V/f without output voltage limiter

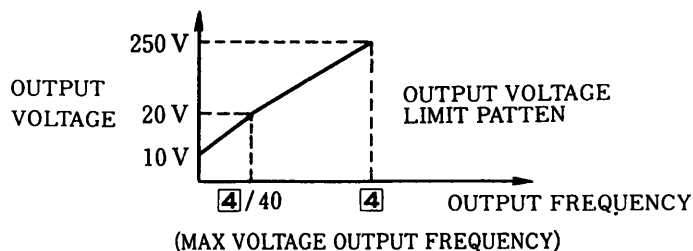

If "1" is set, V/f matching the motor characteristics must be selected.

9-STEP SPEED CHANGE

Item Name	Constant to be Set	Factory Preset
Multi-speed frequency reference	13 to 17, 41 to 44	See pages 39 and 42.
Multi-speed operation function	32 33	See page 41.

Up to 9 steps of speeds can be set using signals from external terminals ⑤ to ⑧. This eliminates the need for an analog signal thereby enabling operation simplified external control. See the following example.

- Set according to run specifications.

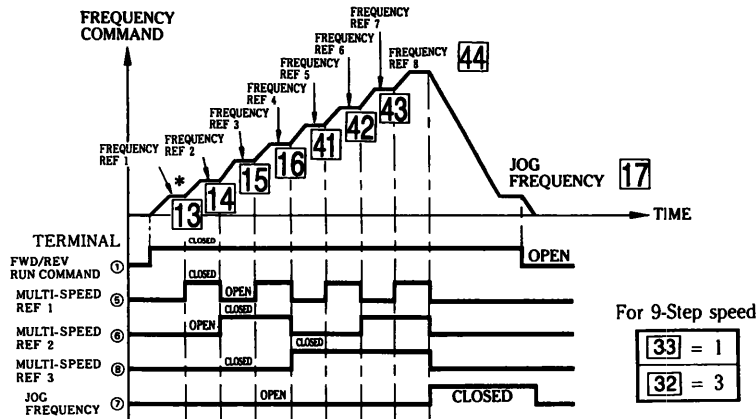

- Notes . 1. When the jog frequency reference and multi-speed reference (1 to 3) are turned on simultaneously, the jog frequency reference has priority over the other.
 2. Frequency reference can be changed only if it is selected by multi-speed reference.
 * Frequency reference from control circuit terminal when setting 11 = ××× 0.

JOG OPERATION

Item Name	Constant to be Set	Factory Preset
Jog frequency reference setting	17	6.0Hz
Jog command selection	32 33	See page 41.

Select the jog mode (connect terminals ⑦-⑨) and jog operation can be performed by FWD/REV run command (when setting 32=1). Depressing the **JOG** key on the digital operator performs the same operation.

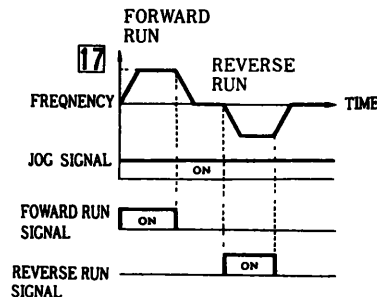

ACCEL/DECEL TIME SETTING

Item Name	Constant to be Set	Factory Preset
Acceleration time 1	[9]	10.0s
Deceleration time 1	[10]	10.0s
Acceleration time 2	[11]	10.0s
Deceleration time 2	[12]	10.0s
Accel/decel time select	[32] [33]	See page 41.

- Each item can be set from 0.0 sec to 600 sec.

The set time indicates the interval required before the maximum output frequency [2] is reached.

Accel/decel time can be set for two-step switching using an external contact, even during running.

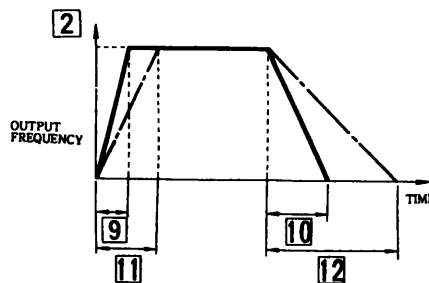

- Open : [9] and [10] are selected.
- Closed : [11] and [12] are selected.
(when setting [33]=2)

Note: S-curve accel/decel is also enabled. When S-curve accel/decel is needed, refer to "S-CURVE PATTERN SELECTION" on page 57.

OUTPUT FREQUENCY CONTROL (GAIN/BIAS)

Item Name	Constant to be Set	Factory Preset
Frequency reference gain	[22]	1.00
Frequency reference bias	[23]	0.00

Output frequency (gain/bias) can be set freely according to frequency setting (0 to 10 V or 4 to 20 mA)

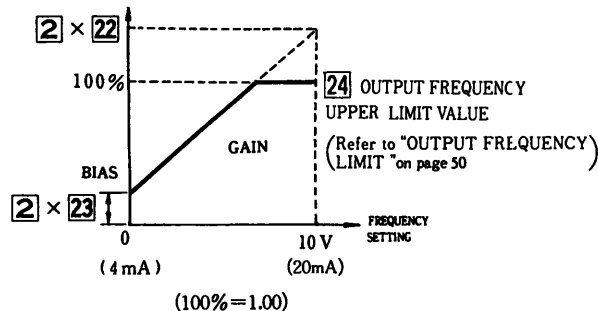

For the setting method, refer to Par. 2.6.1 "Adjustment of Frequency Setting Value, Output Frequency Bias (No.23) and Gain (No.22)" on page 35.

ELECTRONIC THERMAL OVERLOAD PROTECTION

Item Name	Constant to be Set	Factory Preset
Motor type	[18]	0000
Motor rated current	[19]	1.9A*

Motor output current is detected by the inverter built-in electronic thermal overload function, and exclusive inverter-use motors or standard motors are prevented from overloading. (No external thermal switch is necessary.)

[19]= Motor rated current value

Set the motor rated current value according to the value on the motor nameplate.

[18]= xx 0 x

2nd digit

0: Standard motor

1: Exclusive-use motor

[18]= xxx 1 can make electronic thermal overload function disabled.

1st digit

0: Electronic thermal overload protection provided

1: Electronic thermal overload protection not provided

[18]= x 0 xx

3rd digit

0: Electronic thermal overload time constant is used for standard motors or exclusive-use motors (standard ratings).

1: Electronic thermal overload time constant is used for motors other than described above (short-term ratings).

* The example represents YASKAWA 0.5HP (0.4kW), 200V, 4-pole motor. The YASKAWA standard motor current value is set at factory prior to shipping.

DIGITAL DISPLAY UNIT AND MULTIFUNCTION ANALOG OUTPUT MONITOR SETTING

Item Name	Constant to be Set	Factory Preset
Output monitor selection	21	0000
Analog monitor gain	45	1.00

Either output frequency or output current can be monitored by analog output between control circuit terminals 18 and 19. (0 to 10V output)

21 = ×× 0 0

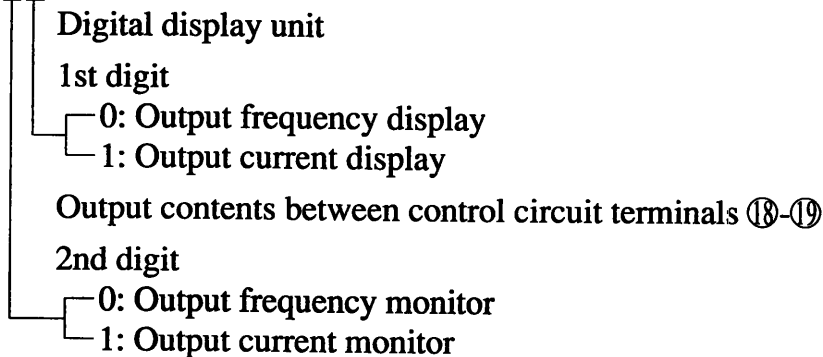

Analog output monitor gain can be set by 45.

Additionally, analog output monitor voltage is output as shown below:

Output frequency monitor:

$$\text{Output voltage (V)} = \text{Output frequency} \times \frac{10\text{V}}{\text{Max. output frequency } 21} \times 45$$

Output current monitor:

$$\text{Output voltage (V)} = \text{Output current} \times \frac{10\text{V}}{\text{Inverter rated current}} \times 45$$

Note: Since output current becomes approx. 200% maximum of the inverter rated current, output voltage is clamped at approx. 11V when 45 is used at 1.00 and the inverter rated current is exceeded. To keep linearity, set 45 to approx. 0.5.

OUTPUT FREQUENCY LIMIT

Item Name	Constant to be Set	Factory Preset
Frequency (speed) reference upper limit	$\boxed{24}$	100%
Frequency (speed) reference lower limit	$\boxed{25}$	0

The upper and lower limits for the output frequency can be clamped. When the lower limit is not the value of minimum output frequency, acceleration to that lower limit setpoint begins unless frequency reference reaches the lower limit value when the start command is input.

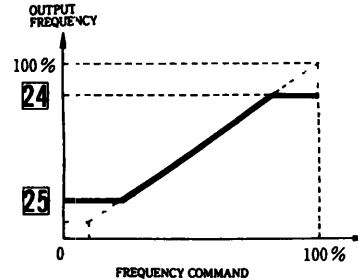

Note : By setting $\boxed{24}$ to 110%, frequency up to $\boxed{2} \times 1.1$ can be output.

(Example) Assuming $\boxed{2} = 60\text{Hz}$, $\boxed{24} = 1.1$, up to 66Hz can be output. However, when the voltage exceeds 400Hz, it is clamped at 400Hz.

DC INJECTION BRAKING

Item Name	Constant to be Set	Factory Preset
DC injection during stop	$\boxed{27}$	0.5s
DC injection at start	$\boxed{28}$	0.0s
DC injection braking current	$\boxed{26}$	50%

• DC injection braking during stop

Prevents overrun at stop.

If output frequency becomes minimum output frequency $\boxed{7}$ or less, DC injection brake is applied for the time set by $\boxed{27}$, and the motor is stopped. By setting 0.0s to $\boxed{27}$, DC injection braking becomes disabled; the motor coasts to a stop when the output frequency is less than the minimum output frequency $\boxed{7}$.

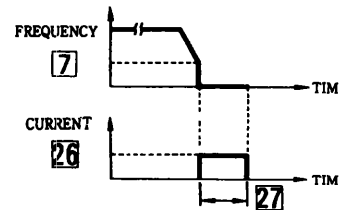

• Starting DC injection braking during start

Stops a coasting motor without tripping even when the direction of rotation is unknown.

When the run command is input, DC injection brake is applied for the time set by $\boxed{28}$, and the motor stops. Then the motor starts operation.

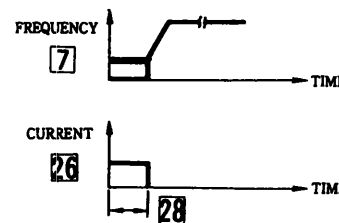

• DC braking current

DC injection braking current 100% equals the inverter rated current. It is set to 50% at factory prior to shipping.

MOTOR STALL PREVENTION FUNCTION

Item Name	Constant to be Set	Factory Preset
Operation level for stall prevention during acceleration	30	170%
Operation level for stall prevention during running	31	160%
Stall prevention function during deceleration	20	0000

Automatically adjusts output frequency according to the load so as to continue operation of the machine without stalling the motor.

• **Stall prevention during acceleration**

If the motor current exceeds the value set to 30 during acceleration, acceleration is stopped until the motor current is reduced to the 30 set value or less.

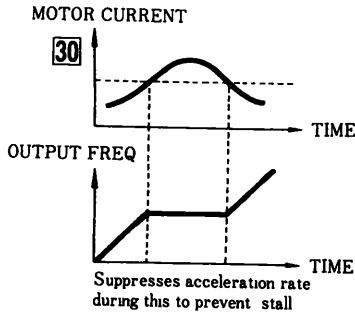

• **Stall prevention during running**

If the motor current exceeds the value set to 31 because of impact load during running, output frequency is automatically lowered. When the motor current is reduced to the 31 set value or less, the motor starts acceleration again and the operation is continued.

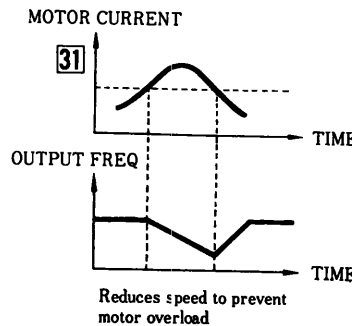

• **Stall prevention during deceleration**

Automatically adjusts deceleration rate with monitoring direct voltage to prevent overvoltage during deceleration. Set "1" for connecting braking resistor.

20 = 0 xxx

- 4th digit
- 0: Stall prevention during deceleration enabled
- 1: Stall prevention during deceleration disabled

FULL-RANGE AUTOMATIC TORQUE BOOST

Item Name	Constant to be Set	Factory Preset
Torque compensation gain	29	1.0

Automatic control of V/f ratio according to the load torque ensures tripless operation and optimum output current. Normally, no adjustment is necessary.

MULTIFUNCTION CONTACT INPUT FUNCTION SELECTION

Item Name	Constant to be Set	Factory Preset
Multifunction contact input function	③② ③③	Refer to page 41.

The function of external output terminals ⑦ and ⑧ can be changed if necessary. Set ③② and ③③ in the descending order.

③② set value < ③③ set value

Terminal ⑦ function: Set to ③②.

Terminal ⑧ function: Set to ③③.

Set Value	Function
0* ¹	FWD/REV run command (3-WIRE sequence selection)
1* ²	JOG command
2* ³	Accel/decel time select
3	Multi-step speed reference 3
4	External baseblock (NO contact input)
5	External baseblock (NC contact input)
6* ⁴	Search from maximum frequency
7* ⁴	Search from set frequency
8* ⁵	Accel/decel hold (output frequency constant)

*1: "0" can be set only to ③②.

*2: Factory preset value of ③②.

*3: Factory preset value of ③③.

*4: For details, refer to "SPEED SEARCH FUNCTION" on page 59.

*5: For details, refer to "ACCEL/DECEL HOLD COMMAND" on page 62.

Terminal function at 3-WIRE sequence selection

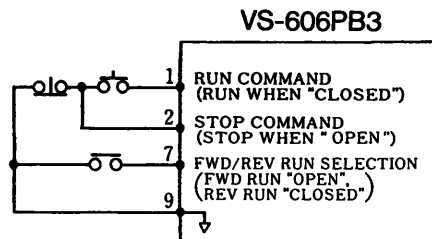

MULTIFUNCTION CONTACT OUTPUT FUNCTION

Item Name	Constant to be Set	FactoryPreset
Multifunction contact output function	34 35	See page 41.

Functions of control circuit terminals ⑭-⑯, and ⑰-⑱ can be switched.

Function of terminal between ⑭-⑯ at “L”: Set into 34.

Function of terminal between ⑰-⑱ at “L”: Set into 35.

Set Value	Function
0*1	In operation
1*2	Agreed frequency
2	Zero speed
3	Frequency detection (output frequency ≥ frequency detection level)
4	Overtorque detected

*1: Factory preset value of 34

*2: Factory preset value of 35

FREQUENCY/CURRENT METER CALIBRATION

Item Name	Constant to be Set	Factory Preset
Analog monitor gain	45	1.00
Output monitor selection	21	0000

Frequency/current meter connected to the inverter can be calibrated by 45 without using a resistor for calibration. For the setting method, refer to “Calibration of Frequency Meter” on page 36 and “Multifunction analog output monitor” on page 49.

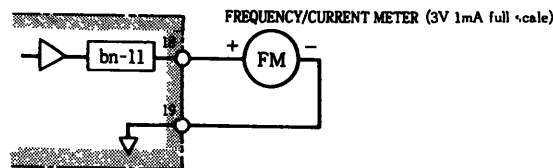

Selection of output between control circuit terminals ⑲-⑳

21 = ×× 0 ×

| 2nd digit
 | — 0: Output frequency
 | — 1: Output current

OVERTORQUE DETECTION FUNCTION

Item Name	Constant to be Set	Factory Preset
Overtorque detection level	38	160%
Overtorque detection time	39	0.1s
Overtorque detection signal	34 35	See page 41.
Overtorque detection selection	37	0000

When excess load is placed on the machine, the increase in motor current is detected. If current exceeding the value set by 38 lasts for a time exceeding the value set by 39, the overtorque detection signal is output to control circuit terminal 14 or 15 until the current is reduced to the 38 set value or less. To output the signal to control circuit terminal 14, set 34 to 4, and to 15, 35 to 4.

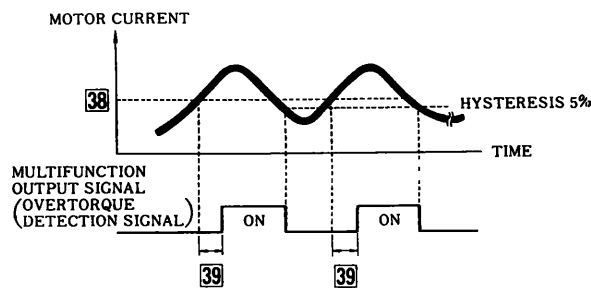

The 37 setting can select overtorque detection only during agreed speed or during running. Additionally, it can select continuous operation or output shut-off at overtorque detection.

- 37 = × 00 ×
- 2nd digit
 - 0: Detected only during agreed speed
 - 1: Detected during running
 - 3rd digit
 - 0: Continuous operation after overtorque detection
 - 1: Output shut off at overtorque detection

CARRIER FREQUENCY

Item Name	Constant to be Set	Factory Preset
Carrier frequency	40	4

Changing the carrier frequency reduces RFI noise and leakage current without increasing motor noise.

$$\text{Carrier frequency (kHz)} = 2.5\text{kHz} \times \text{set value}$$

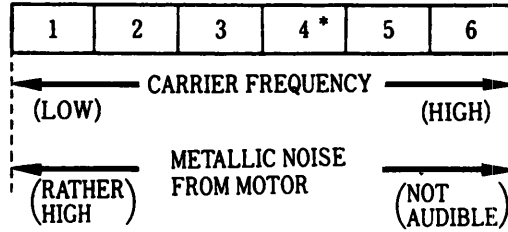

* Factory preset value

Note : Reduce continuous output current for changing the frequency to 5 or 6.

Carrier Frequency Set Value	Maximum Continuous Output Current
1 to 4	Overload not provided: Up to 112% of inverter rated output current Overload provided: Up to 100% of inverter rated output current
5, 6	Overload not provided: Up to 100% of inverter rated output current Overload provided: Up to 90% of inverter rated output current

ARBITRARY SPEED DETECTION LEVEL ADJUSTMENT AND SELECTION

Item Name	Constant to be Set	Factory Preset
Frequency detection level	36	0.0Hz
Multifunction contact output function	34 35	See page 41.

This function is used when operation at an arbitrary speed must be indicated. By setting either set value to multifunction contact output function (34, 35), the following signal output to control circuit terminal 14 or 15 is enabled. Set 1 or 3 to 34 or 35 when the signal is to be output to control circuit terminal 14 and 15, respectively.

(1) Set value=1 : agreed frequency

(2) Set value=3 : output frequency \geq frequency detection level

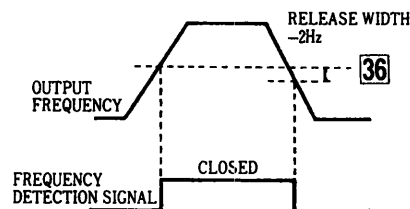
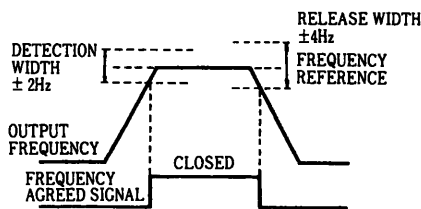

However, when “agreed frequency” is selected, the frequency agreed signal is turned OFF immediately at stop signal input.

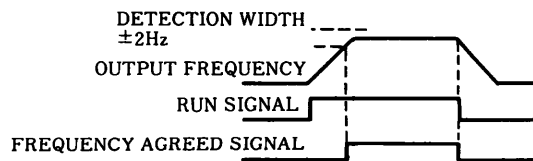

S-CURVE PATTERN SELECTION

Item Name	Constant to be Set	Factory Preset
S-curve pattern selection	21	0000

To prevent shock at machine starting/stopping, accel/decel in S-curve pattern is enabled by the setting of 21.

21 = 00xx

3rd, 4th digits

- 00: S-curve section not provided (linear accel/decel)
- 01: S-curve section 0.2 second
- 10: S-curve section 0.5 second
- 11: S-curve section 1 second

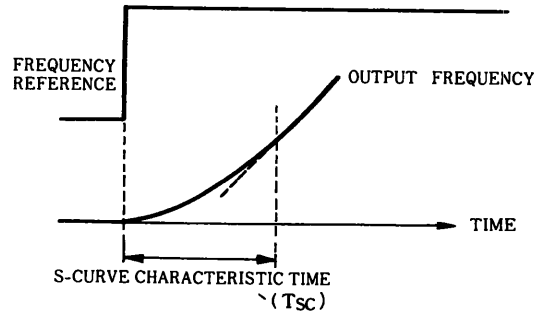

Note: S-curve characteristic time refers to the time from the acceleration rate 0 to regular acceleration rate determined by the set acceleration time.

The following shows the time chart at FWD/REV run switching at deceleration to a stop.

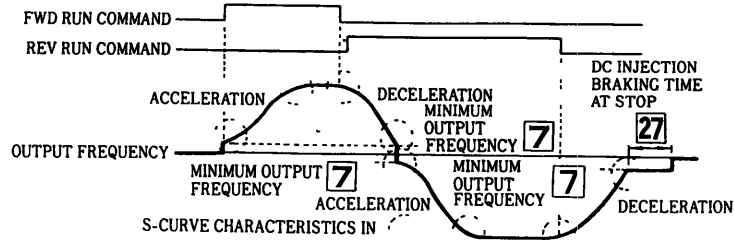

PROHIBITED FREQUENCY SETTING

Item Name	Constant to be Set	Factory Preset
Prohibited frequency 1	50	0.0Hz
Prohibited frequency 2	51	0.0Hz
Prohibited frequency 3	52	0.0Hz
Prohibited width	53	1.0Hz

To operate the inverter without resonance caused by machine system characteristic frequency, resonance generating frequency can be prohibited. This function can be also for dead band control.

Constant-speed operation is prohibited within the prohibited width. However, output frequency is not prohibited during acceleration or deceleration for smooth acceleration or deceleration.

(1) Prohibited frequency 1 to 3 (50 to 52)

By setting the value to 0.0Hz, this function becomes disabled. Set prohibited frequency 1 to 3 as described below :

Prohibited frequency 3 52 ≤ Prohibited frequency 2 51 ≤ Prohibited frequency 1 50

(2) Prohibited width (53)

By setting the value to 0.0Hz, this function becomes disabled. The prohibited range is :

50 to 52 - 53 < prohibited range < 50 to 52 + 53

(Example) When prohibited frequency 1 50 is 45Hz and the prohibited width 53 is 2.0Hz : Prohibited range: 43 to 47Hz.

SPEED SEARCH FUNCTION

Item Name	Constant to be Set	Factory Preset
Speed search function	32 33	See page 41.
Speed search operation level	54	150%
Minimum baseblock time	55	0.5s

When the motor during coasting is started during changing operation of commercial power supply and inverter, etc., the motor can be operated without tripping by using the speed search function.

The speed search command is input from control circuit terminals ⑦ and ⑧. For the functions of terminals ⑦ and ⑧, “6” or “7” is set to 32 or 33.

When setting to “6”: Search from maximum frequency

When setting to “7”: Search from set frequency

By closing the search command during baseblock and inputting the run command, speed search is started after the inverter output is shut off for the minimum baseblock time 55.

When the inverter output current is larger than the set value of the speed search operation level 54, the speed search operation starts. Frequency in which the inverter output current becomes smaller than the speed search operation level 54 set value is judged to be the speed agreed point, and the motor starts reacceleration/redeceleration up/down to the set frequency in the set accel/decel time.

The following shows the time chart where the speed search command is input.

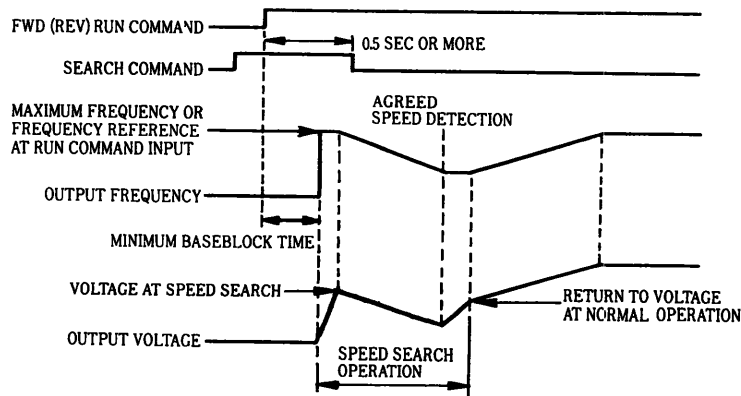

Notes:

1. When the search commands are input from maximum frequency and set frequency are input simultaneously, the search command from maximum frequency has the priority.
2. Make such sequence that FWD (REV) run command is to be input at the same time or after the search command.

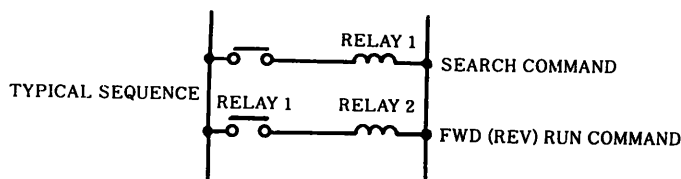

CONTINUOUS OPERATION AT MOMENTARY POWER LOSS

Item Name	Constant to be Set	Factory Preset
Operation selection after momentary power loss	46	0000
Speed search operation level	54	150%
Minimum baseblock time	55	0.5s

Even if a momentary power loss occurs, operation can be continued without any problem.

46 = xxx 0

1st digit

- 0: Continuous operation after momentary power loss not provided
- 1: Continuous operation after momentary power loss provided

Momentary power loss ride-thru time differs as shown below, according to the capacity of the models. (common to both 3-phase and single-phase)

- 0.25 to 1HP (0.2 to 0.75kW) : Approx. 1 second
- 2 to 5HP (1.5 to 3.7 kW) : Approx. 2 seconds

Operation when continuous operation after momentary power loss is provided is as described below:

- ① When undervoltage (UV) is detected, the inverter output is shut off and the frequency reference value and run command given before the momentary power loss are held. Additionally, counting of the undervoltage time starts; during counting, \underline{UV} is displayed, blinking on the digital display unit and digital operator. If undervoltage is detected, the inverter output is shut off for the minimum baseblock time 55.
- ② After recovery from the momentary power loss, after checking that the inverter DC voltage has recovered sufficiently, speed search operation is performed.
- ③ Speed search operation starts when the inverter output current exceeds the speed search operation level 54 set value. At this time, the new frequency reference value and run command are read in. The frequency in which the inverter output current is smaller than the speed search operation level 54 set value is judged to be the speed agreed point, and reacceleration/redeceleration is performed up/down to the set frequency in the set accel/decel time.

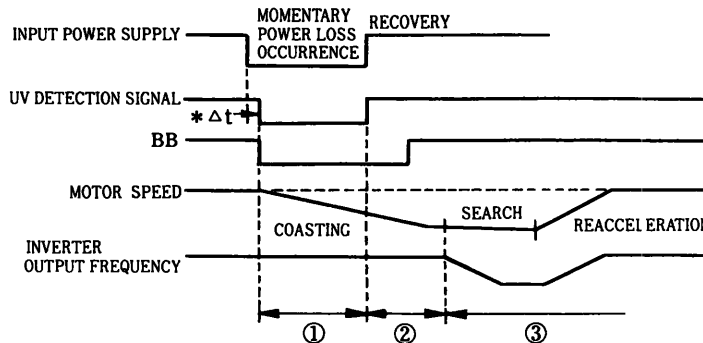

* Δt : Varies according to the inverter load size. (Assured at 15msec minimum.)
 Operation is automatically continued if recovery from momentary power loss in Δt or less

AUTOMATIC RESTART FUNCTION AFTER A FAULT

Item Name	Constant to be Set	Factory Preset
Fault retry selection	47	0
Speed search operation level	54	150%
Minimum baseblock time	55	0.5s
V/f during speed search	56	100%

If an inverter fault occurs during running, the inverter performs self-diagnosis to restart automatically.

The number of the self-diagnosis and restarting times can be set up to 10 times to 47.

By setting 0 times, the fault retry function becomes disabled.

- ① Overcurrent protection (OC)
- ② Overvoltage protection (OV)
- ③ Cooling fin overheat (OH)
- ④ Ground fault (GF) : only with model CIMR-PBE.

The number of fault retry times is cleared to 0 in the following cases:

- ① No fault occurs for more than 10 minutes
- ② Fault reset input signal (or ➤
RESET key on the digital operator) is turned on when the fault is checked.
- ③ The power supply is turned off.

Fault retry operation is described below:

- ① If a fault is detected, the inverter output is shut off for the minimum baseblock time 55. While the inverter output is shut off, the fault is displayed on the digital display unit and the digital operator.
- ② After the minimum baseblock time 55, the fault is automatically reset, and the speed search operation is performed from the output frequency at the fault occurrence.
- ③ If the inverter output current is larger than the speed search operation level 54 set value, the speed search operation starts. The frequency in which the inverter output current is smaller than the speed search operation level 54 set value is judged to be the speed agreed point, and reacceleration/redeceleration is performed up/down to the set frequency in the set accel/decel time.
- ④ If the total number of faults exceeds the number of retry times 47, automatic reset is not performed and the inverter output is kept off. Then fault contact is output. (Fault contact is not output during fault retry.)

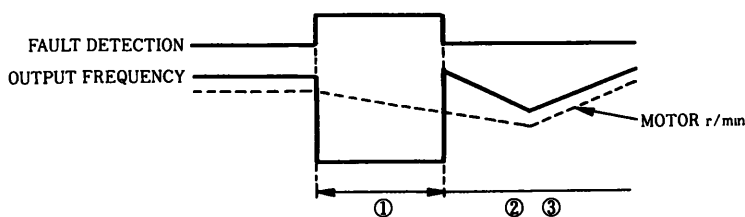

Note: V/f during speed search

The V/f during speed search can be set as shown below by the 56 set value so that a fault such as OC will not occur during speed search. However, this setting is not needed under normal operation.

V/f during speed search = V/f under normal operation \times 56

ACCEL/DECEL HOLD COMMAND

Item Name	Constant to be Set	Factory Preset
Accel/decel hold function	32 33	See page 41:

When the accel/decel hold command is input during acceleration or deceleration, acceleration or deceleration is prohibited while the command is input, and the output frequency is held.

By inputting the stop command, the accel/decel hold command is released and the operation is in the stopped condition.

The accel/decel hold command is input from control circuit terminal ⑦ or ⑧.

For the function of terminal ⑦ or ⑧, set "8" to 32 or 33.

Terminal ⑦ function: Set to 32.

Terminal ⑧ function: Set to 33.

The following shows the time chart when the accel/decel hold command is input:

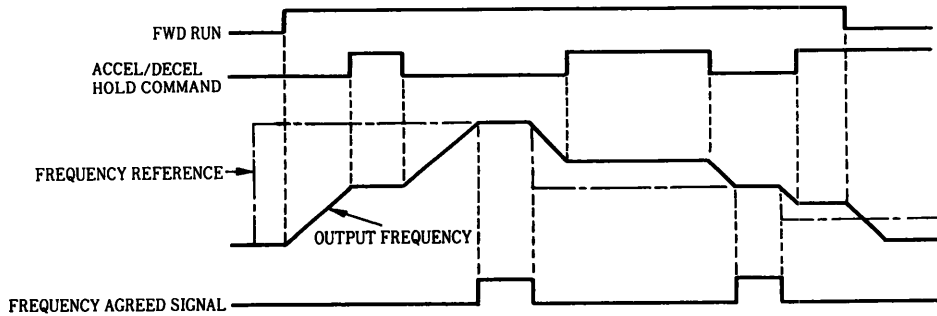

Note: When the FWD (REV) run command is input in the status where the accel/decel hold command is input, the baseblock status is continued and the motor does not operate. However, when frequency reference lower limit 25 \geq minimum output frequency 7 is set, the motor operates at the frequency reference lower limit 25.

CONSTANTS EFFECTIVE FOR REDUCTION OF MACHINE VIBRATION OR SHOCK

The following constants are effective for reduction of vibration or shock.

Effective Method	Constant to be Set	Factory Preset
Shock		
• To decrease generating torque • To increase generating torque	2 to 8	See page 38.
	29	1.0
To reduce shock at acceleration	21	0000
	9 11	10.0s
	30	170%
To reduce shock at deceleration	1	0000
	21	0000
	10 12	10.0s
	7	1.5Hz
	26	50%
Vibration		
To decrease carrier frequency	40	4

2.10 PROTECTIVE FUNCTIONS

Protective Function		Explanation	Monitor Display	Fault Contact Output
Low voltage protection	Main circuit voltage low	When the inverter power supply voltage drops, torque becomes insufficient and motor is overheated. Inverter output is stopped when the main circuit DC voltage becomes lower than the low voltage detection level for 15 ms or longer. Detection level Approximately 210V or less (3-phase), 170V (single-phase)	UV1 (UV1)	Operation
Overcurrent protection		The inverter output is shut-off when the inverter output current becomes approx. 200% and above of inverter rated current.	OC (OC)	Operation
Ground-fault protection *4		The inverter output is shut-off when a ground-fault occurs at the inverter output side	GF (GF)	Operation
Overvoltage protection		The inverter output is shut-off when the main circuit DC voltage becomes excessive because of regeneration energy caused by motor deceleration and negative load. Detection level. Approx 410V or more	OV (OV)	Operation
Fuse blown		The fuse clears to prevent wiring from being damaged by the short-circuit current when the main circuit transistor fails	(Not displayed)	Non Operation
Cooling fin overheat		The inverter output is shut-off when the cooling fin overheat is detected by thermistor Check for a defective cooling fan or clogged filter	OH (OH)	Operation
Overload protection	Motor	Inverter output is stopped when output current to the motor is detected by the electronic thermal in the inverter Either an inverter duty constant-torque specialized motor or general-purpose motor can be selected If more than one motor is driven, overload protection should be disabled Use a thermal relay or thermal protector for each motor.	OL1 (OL1)	Operation
	Inverter	The inverter output is shut-off when the electronic thermal overload reaches or exceeds the inverse time limit of 112% of the inverter's rated current occurs Maximum rated overload: 150%, 1min	OL2 (OL2)	Operation
	Overtorque detection *1	The motor operates according to operation selection [constant (No 37)] when the inverter output current exceeds the overtorque detection level. This function is used to protect the machine or to monitor the output torque.	OL3 (OL3)	Operation
External fault signal input		When an external alarm signal is input, the inverter output is shut-off	EF3 (EF3)	Operation
Control circuit fault *2		The inverter output is shut-off when a transmission error occurs in the control circuit or a component fails.	FO4 FO5 FO7 CPFO0 to CPFO7 *3	Operation

*1: For overtorque detection (OL3), fault display or alarm display can be selected according to the constant (No.37) setting. For details, refer to "OVERTORQUE DETECTION FUNCTION" on page 54.

*2: For details of control circuit faults, refer to Table 5.1 "Details of CPF-□□ Display" on page 18.

*3: CPFO0 to 07 indicate the contents of digital operator display.

*4: Ground fault protection is provided only with model CIMR-PBE.

	Error Causes	Action to be Taken
	<ul style="list-style-type: none"> •Inverter capacity is too small. •Voltage drop due to wiring •A motor of large capacity (11 kW or greater) connected to the same power system has been started. •Rapid acceleration with generator power supply •Operation sequence when power is off •Defective electromagnetic contactor 	<ul style="list-style-type: none"> •Check the power supply voltage. •Check the power capacity and power system.
	<ul style="list-style-type: none"> •Extremely rapid accel/decel •Motor on/off switching at the inverter output side •Short-circuit at the inverter output side •Motor of a capacity greater than the inverter rating has been started. •High-speed motor or pulse motor has been started. 	<p>Transistor error may occur. Investigate the error cause, correct it, then restart.</p>
	<p>Ground-fault at the inverter output side</p>	<ul style="list-style-type: none"> •Check that motor insulation is not deteriorated. •Check that wirings of load side are not damaged.
	<ul style="list-style-type: none"> •Overvoltage •Insufficient deceleration time •Regenerative load (Motor is turned by the load.) •High input voltage compared to motor rated voltage 	<ul style="list-style-type: none"> •If braking torque is not proper, extend the decel time or connect a braking resistor unit (option). •Check that the load is not minus •Check the power supply voltage.
	<ul style="list-style-type: none"> •Repeated overcurrent protection (OC) •Repeated overload protection (OL2) power reset •Rapid deceleration in excess excitation (improper V/f characteristic setting) 	<ul style="list-style-type: none"> •Turn off the power supply once and turn it on again. If the fault occurs again after replacement, replace the inverter. •Do not replace the fuse
	<ul style="list-style-type: none"> •Defective cooling fan •Ambient temperature rise •Clogged filter 	<ul style="list-style-type: none"> •Wash the filter. •Replace the inverter when the inverter cooling fin is defective. •Intake air temperature 113°F (45°C) or less
	<ul style="list-style-type: none"> •Overload, low speed operation or extended acceleration time, improper V/f characteristic setting •Motor rated current [constant (No 19)] setting is wrong. 	<ul style="list-style-type: none"> •Investigate the cause of overload and review the operation pattern, V/f characteristic, and motor/inverter capacities (If inverter is repeatedly reset after an overload occurs, the inverter may fault. Investigate and correct the cause of overload before restart) •Set the rated current of motor nameplate value to constant (No 19). •If the above measures are not effective, lower the carrier frequency [constant (No 40)]
	<p>Motor current exceeds the preset value because of machine error or overload</p>	<p>Check the use of the machine. Correct the overload cause or set a higher detection level [constant (No. 38)] which is within the allowable range</p>
	<p>External fault condition occurred.</p>	<p>Correct the cause of the fault input.</p>
	<ul style="list-style-type: none"> •External noise •Excess vibration or shock 	<ul style="list-style-type: none"> •Record all data of <i>FO4</i> and <i>CPFO4</i>, then make initialization •Turn off power, then turn on again. If error is persistent, replace the inverter.

2.11 PROTECTIVE FUNCTIONS (WARNINGS)

Protective Function		Explanation	Monitor Display	Fault Constant Output
Low-voltage protection (main circuit voltage insufficient)		Monitor display appears when the main circuit DC voltage drops under the detection level while the inverter output is off. Detection level : Approx. 210V or less (3-phase) Approx. 170V or less (single-phase)	(UV) uv (Blink)	Non operation
Overtorque detection		This function is used to protect the machine and to monitor the inverter's output torque. The motor operates according to selection of constant (No.37) when the inverter output current exceeds the overtorque detection level. The monitor blinks when "operation continue" is preset.	(OL3) ol3 (Blink)	Non operation
Stall prevention (Accel/ decel is accomplished with maximum capacity of the inverter without tripping on overcurrent or over-voltage.)	During acceleration	Inverter acceleration is stopped when 170% or more of the inverter rated current is required by the load. This prevents overload protection (OL1, OL2) or overcurrent (OC) from occurring. When current is reduced to less than 170%, acceleration is enabled.	—	Non operation
	During normal operation	Output frequency is decreased when 160% of the inverter rated current or greater is required by the load. This prevents motor and inverter overload (OL1, OL2). When current is reduced below 160%, inverter acceleration is enabled.		
	During deceleration	Deceleration is stopped when the DC voltage is caused to rise by motor regenerative energy. This prevents overvoltage trips (OV). When DC voltage decreases, deceleration to the set value then resumes.		
Simultaneous forward and reverse run commands		When forward and reverse run commands are simultaneously closed for a period of time exceeding 500 ms, the inverter is stopped according to the preset stop method [constant (No.01)].	(EF) EF (Blink)	Non operation
External baseblock signal input (main circuit transistor instantaneous shut-off)		When an external baseblock signal is input, the motor coasts to a stop. When the external baseblock signal is removed, the inverter output is immediately turned on at the previously set frequency.	(BB) bb (Blink)	Non operation

	Error Causes	Action to be Taken
	<ul style="list-style-type: none"> •Input voltage drop 	<ul style="list-style-type: none"> •Check the main circuit DC voltage. •Check the power supply capacity and power system.
	<ul style="list-style-type: none"> •Motor current exceeded the set value because of machine fault or overload. 	<ul style="list-style-type: none"> •Check the driven machine and correct the cause of the fault or increase the set value [constant (No.38)] up to the machine allowable value.
	<ul style="list-style-type: none"> •Insufficient power for accel/decel •Overload •Phase loss 	<ul style="list-style-type: none"> •Set proper accel/decel time [constant (Nos.09 to 12)] for smooth operation. •For stall prevention during normal operation lighten the load or increase inverter capacity.
	<ul style="list-style-type: none"> •Operation sequence error •3-wire/2-wire selection error 	<ul style="list-style-type: none"> •Recheck the control sequence. •Recheck constant settings (No. 32 and 33).
	<p>_____</p>	<p>_____</p>

Varispeed-606PB3

PLASTIC-COVERED BOOK-SIZE ALL-DIGITAL
LOW-NOISE INVERTER

MODEL : CIMR-PBA2, -PBE2 (3-PHASE SERIES)
CIMR-PBAB, -PBEB (SINGLE-PHASE SERIES)

TOKYO OFFICE Ohtemachi Bldg, 1-6-1 Ohtemachi, Chiyoda-ku, Tokyo, 100 Japan
Phone (03) 3284-9111 Telex YASKAWA J33530 Fax (03) 3284-9034

SEOUL OFFICE 8th Floor Seoul Center Bldg, 91-1, Sogong-Dong, Chung-ku, Seoul, Korea 100-070
Phone (02) 776-7844 Fax (02) 753-2639

TAIPEI OFFICE Shen Hsiang Tang Sung Chiang Building 10F 146 Sung Chiang Road, Taipei, Taiwan
Phone (02) 563-0010, -7732 Fax (02) 567-4677

YASKAWA ELECTRIC AMERICA, INC
Chicago-Corporate Headquarters 2942 MacArthur Blvd Northbrook, IL 60062-2028, U S A
Phone (708) 291-2340 Fax (708) 498-2430
Chicago-Technical Center 3160 MacArthur Blvd Northbrook, IL 60062-1917, U S A
Phone (708) 291-0411 Fax (708) 291-1018

MOTOMAN INC
805 Liberty Lane West Carrollton, OH 45449, U S A
Phone (513) 847-6200 Fax (513) 847-6277

YASKAWA ELECTRIC EUROPE GmbH
Am Kronberger Hang 2, 65824 Schwalbach, Germany
Phone (49) 6196-569-300 Fax (49) 6196-888-301

Motoman Robotics AB
Box 130 S-38500 Torsås, Sweden
Phone 0486-10575 Fax 0486-11410

Motoman Robotec GmbH
Kammerfeldstraße 1, 8051 Allershausen, Germany
Phone 08166-900 Fax 08166-9039

YASKAWA ELECTRIC UK LTD
3 Drum Mains Park Orchardton Woods Cumbernauld, Scotland, G68 9LD U K
Phone (236)735000 Fax (236)458182

YASKAWA ELÉTRICO DO BRASIL COMÉRCIO LTDA
Rua Conde Do Pinhal 8-5°, Andar Sala 51 CEP 01501-São Paulo-SP, Brasil
Phone (011) 35-1911 Fax (011) 37-7375

YASKAWA ELECTRIC (SINGAPORE) PTE LTD
Head Office CPF Bldg, 79 Robinson Road # 13-05, Singapore 0106, SINGAPORE
Phone 221-7530 Telex (87) 24890 YASKAWA RS Fax 224-5854
Service Center 221 Henderson Road, # 07-20 Henderson Building Singapore 0315, SINGAPORE
Phone 276-7407 Fax 276-7406

YATEC ENGINEERING CORPORATION
Shen Hsiang Tang Sung Chiang Building 10F 146 Sung Chiang Road, Taipei, Taiwan
Phone (02) 563-0010 Fax (02) 567-4677



YASKAWA

YASKAWA ELECTRIC CORPORATION



* T O E - S 6 0 6 - 1 D *

TOE-S606-1D

© Printed in Japan September 1994 92-1 2W
502 266